



INSTRUCTION MANUAL

MF/HF MARINE TRANSCEIVER
IC-M710RT

Icom Inc.

IMPORTANT

READ THIS INSTRUCTION MANUAL CAREFULLY before attempting to operate the transceiver.

SAVE THIS INSTRUCTION MANUAL—This manual contains important safety and operating instructions for the IC-M710RT MF/HF MARINE TRANSCEIVER.

EXPLICIT DEFINITIONS

The explicit definitions described below apply to this instruction manual.

WORD	DEFINITION
 WARNING	Personal injury, fire hazard or electric shock may occur.
CAUTION	Equipment damage may occur.
NOTE	If disregarded, inconvenience only. No risk of personal injury, fire or electric shock.

 **NOTE:** The IC-M710RTGMDSS version has a high-stability crystal oscillator unit. This unit draws a slight current even when power to the transceiver is OFF. To prevent battery exhaustion when docking your vessel for extended periods, unplug the DC cable from the DC power receptacle.

PRECAUTIONS

 **WARNING! NEVER** connect the transceiver to an AC outlet directly. This may pose a fire hazard or result in an electric shock.

 **WARNING! NEVER** mount the transceiver overhead. The weight of the transceiver is approximately 8 kg., but its apparent weight will increase several fold due to wave shocks and vibration. The transceiver must be mounted on a flat hard surface only.

NEVER connect a power source of more than 16 V DC such as a 24 volt battery. This connection will ruin the transceiver.

NEVER place the transceiver where normal operation of the ship or vehicle may be hindered or where it could cause bodily injury.

Place unit in a secure place to avoid inadvertent use by children.

NEVER expose the transceiver to rain, snow or any liquids.

There are two types of grounding systems available for the IC-M710RT—Negative Ground and Floating Ground—**NEVER** install the negative ground type to a plus-grounding ship. Such a connection might blow fuses and is not usable.

DO NOT use chemical agents such as benzene or alcohol when cleaning, as they can damage the transceiver's surfaces.

In maritime mobile operation, **KEEP** the transceiver and microphone as far away as possible (at least 1 m) from the magnetic navigation compass to prevent erroneous indications.

USE an Icom microphone and/or handset only (supplied or optional). Other brands may have different pin assignments and may damage the transceiver.

AVOID using or placing the transceiver in areas with temperatures below -20°C (-4°F) or above $+60^{\circ}\text{C}$ ($+140^{\circ}\text{F}$).

AVOID connecting the transceiver to a power source using reverse polarity. This connection will not only blow fuses but may also damage the transceiver.

AVOID placing the transceiver in excessively dusty environments or in direct sunlight.

AVOID placing the transceiver against walls or putting anything on top of the transceiver. This will obstruct heat dissipation.

IN CASE OF EMERGENCY (for maritime operation)

If your vessel requires assistance, contact other vessels and the Coast Guard by sending a distress call on 2182 kHz.

Or, transmit your distress call using digital selective calling on 2187.5 kHz.

○ USING 2182 kHz WITH VOICE

- ① Push [2182kHz] to select the emergency frequency.
- ② Push [ALARM] and [TX FREQ] for 1 sec. to transmit a 2-tone alarm signal for at least 30 sec.
 - The transceiver automatically stops the alarm after 50 sec.
- ③ Push [ALARM] to turn the alarm transmission off, then push and hold the PTT switch on the microphone and send the following information:
 1. "MAYDAY, MAYDAY, MAYDAY."
 2. "THIS IS" (name of vessel)
 3. "LOCATED AT" (vessel's position)
 4. Give the reason for the distress call.
 5. Explain what assistance you need.
 6. Give additional information:
 - Vessel type
 - Vessel length
 - Vessel color
 - Number of people onboard.

○ USING DIGITAL SELECTIVE CALLING

(Only for GMDSS versions with an optional GM-110DSC DSC TERMINAL UNIT)

When immediate help is needed

- ① Push and hold [EMERGENCY] on the GM-110DSC for 5 sec., until the short beeps become one long beep, to send the distress call.
- ② After 2182 kHz is automatically selected, transmit the appropriate information as at left using voice.

When a potential problem exists

- ① Push [SEL] on the GM-110DSC, then select "all ships call" with [ENT] and the DATA SELECTOR.
- ② Push and hold [CALL] on the GM-110DSC for 5 sec., until short beeps become one long beep, to use the "all ships call" function.
- ③ After the pre-selected frequency is selected, transmit the appropriate information using voice.
 - DSC equipped ships may monitor your transmission.

VERSIONS

The following versions are available for the IC-M710RT:

Version	Ground type	Description
GMDSS	Negative ground and Floating ground	Corrosion-resistant exterior. High stability crystal and FSK narrow filter built-in. Optional DSC terminal unit can be connected. 2182 kHz 2-tone alarm is built-in.
Marine	Negative ground and Floating ground	2182 kHz 2-tone alarm is built-in. FSK/CW narrow filter is optional. All SSB/FSK ITU channels available.
General	Negative ground only	2182 kHz 2-tone alarm is optional. FSK/CW narrow filter is optional. ITU channels are optional.

TABLE OF CONTENTS

IMPORTANT	ii	6 SET MODE	12–15
EXPLICIT DEFINITIONS	ii	■ Set mode operation	12
PRECAUTIONS	ii	■ Set mode contents	12
IN CASE OF EMERGENCY	iii	7 CONNECTIONS AND INSTALLATION	16–25
VERSIONS	iii	■ Supplied accessories	16
TABLE OF CONTENTS	iv	■ Attaching 1 remote controller	16
1 OPERATING RULES AND GUIDELINES	1	■ Attaching 2 remote controllers	17
2 PANEL DESCRIPTION	2–5	◇ Set ID number	17
■ Front panel	2	◇ Intercom operation	17
■ Main unit	4	■ Attaching 2 remote controllers and a PC	18
◇ HM-120 microphone keys	4	■ Notes for remote control	18
■ Display	5	■ Connections on rear panel	19
3 SELECTING A CHANNEL/FREQUENCY	6–8	■ Connector information	20
■ Selecting a channel	6	■ Ground connection	22
◇ Using the channel selector	6	■ Power source	22
◇ Using the keypad	7	■ Antenna	23
◇ Scan functions	7	◇ MN-100/MN-101L	23
■ Selecting a frequency	8	◇ AT-130	23
◇ Using the channel selector	8	◇ Non-Icom tuner	23
◇ Using the keypad	8	■ Mounting	24
4 RECEIVE AND TRANSMIT	9–11	◇ Mounting location	24
■ Basic voice receive and transmit	9	◇ Mounting example	24
■ Functions for transmit	9	◇ Transceiver dimensions	24
◇ Transmit frequency check	9	■ Installing internal options	25
◇ Transmit power selection	9	◇ Opening the case	25
■ Functions for receive	10	◇ Installing an optional filter and alarm unit	25
◇ Squelch function	10	■ Fuse replacement	25
◇ Noise blanker	10	8 TROUBLESHOOTING	26
◇ AGC off function	10	9 SPECIFICATIONS AND OPTIONS	27
◇ RF gain setting	10	■ Specifications	27
◇ Clarity control	10	■ Options	27
■ CW operation	11		
■ FSK operation	11		
■ Cross channel operation	11		
5 USER CHANNEL PROGRAMMING	12		
■ Programming a frequency	12		
◇ Receive frequency	12		
◇ Transmit frequency	12		
◇ Channel names	12		

☐ CALL PROCEDURES

Calls must be properly identified and time limits must be respected.

- ① Give your call sign each time you call another vessel or coast station. If you have no call sign, identify your vessel name and the name of the licensee.
- ② Give your call sign at the end of each transmission that lasts more than 3 min.
- ③ You must break and give your call sign at least once every 15 min. during long ship-to-shore calls.
- ④ Keep your unanswered calls short, less than 30 sec. Do not repeat a call for 2 min.
- ⑤ Unnecessary transmissions are not allowed.

☐ PRIORITIES

- ① Read all rules and regulations pertaining to priorities and keep an up-to-date copy handy. Safety and distress calls take priority over all others.
- ② False or fraudulent distress calls are prohibited and punishable by law.

☐ PRIVACY

- ① Information overheard but not intended for you cannot be lawfully used in any way.
- ② Indecent or profane language is prohibited.

☐ LOGS

- ① All distress, emergency and safety calls must be recorded in complete detail. Log data activity is usually recorded in 24 hour time. Universal Time (UTC) is frequently used.
- ② Adjustments, repairs, channel frequency changes and authorized modifications affecting electrical operation of the equipment must be kept in the maintenance log; entries must be signed by the authorized licensed technician performing or supervising the work.

☐ RADIO LICENSES

(1) SHIP STATION LICENSE

You must have a current radio station license before using the transceiver. It is unlawful to operate a ship station which is not licensed.

Inquire through your dealer or the appropriate government agency for a Ship-Radiotelephone license application. This government-issued license states the call sign which is your craft's identification for radio purposes.

(2) OPERATOR'S LICENSE

A Restricted Radiotelephone Operator Permit is the license most often held by small vessel radio operators when a radio is not required for safety purposes.

The Restricted Radiotelephone Operator Permit must be posted or be kept with the operator. Only a licensed radio operator may operate a transceiver.

However, non-licensed individuals may talk over a transceiver if a licensed operator starts, supervises, and ends the call, and makes the necessary log entries.

Keep a copy of the current government rules and regulations handy.

■ Front panel (controller)

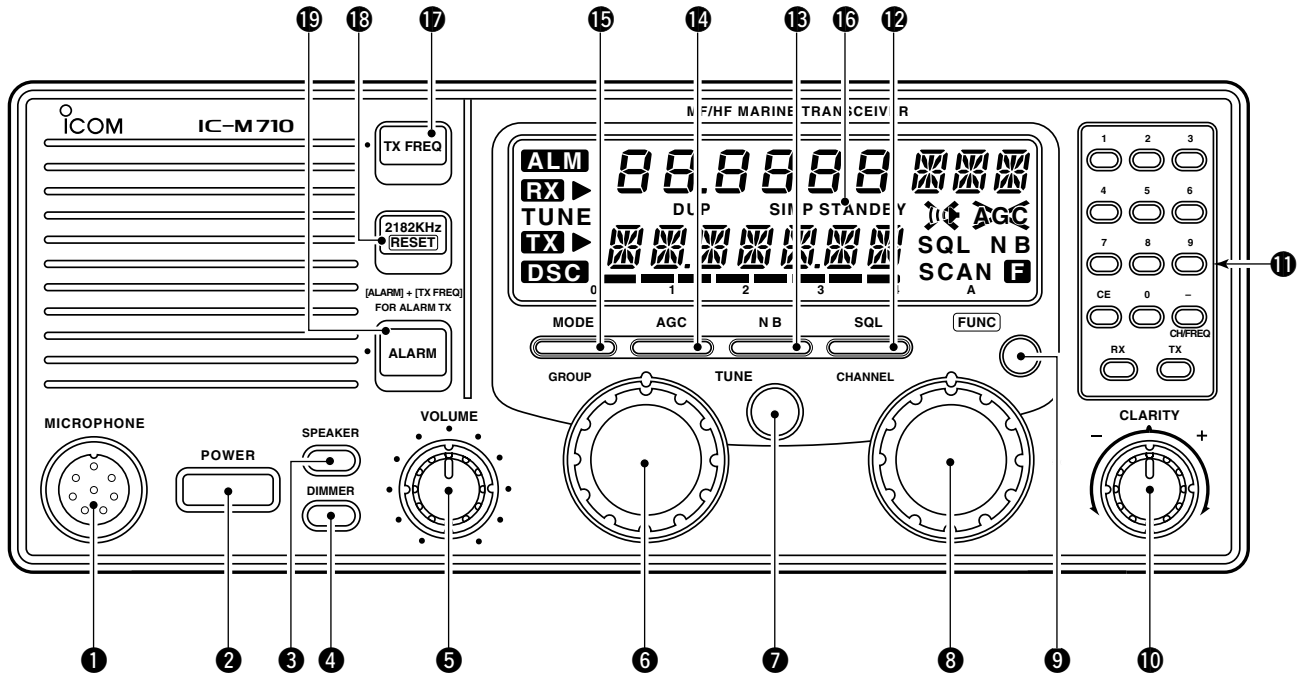

1 MICROPHONE CONNECTOR (p. 20)

Accepts the supplied microphone or an optional handset.

NOTE: No audio is output via the speaker when the microphone or handset is not connected.

2 POWER SWITCH [POWER]

Turns power on and off.

3 SPEAKER SWITCH [SPEAKER]

Turns the built-in speaker on and off.

- “” appears in the display while the speaker is turned off.
- Any external speaker connected to the rear panel is not turned off.

4 DISPLAY INTENSITY SWITCH [DIMMER]

- ➔ Toggles the display backlight on and off.
- ➔ While pushing, rotate [CHANNEL] to adjust the backlighting to one of 4 levels.
- ➔ While pushing, rotate [GROUP] to adjust the display contrast to one of 10 levels.

5 VOLUME CONTROL [VOLUME]

Adjusts the audio output level.

- Audio does not come from the speaker when:
 - ➔ A microphone is not connected.
 - ➔ The [SQL] switch is turned on and no signal is being received.

6 GROUP CHANNEL SELECTOR [GROUP]

Selects groups in 20 channel steps and ITU marine channel groups.

NOTE: Some versions have no ITU channels.

7 ANTENNA TUNE SWITCH [TUNE] (p. 9)

Tunes the connected tuner to the antenna.

- Activates only when an optional antenna tuner such as Icom's AT-130/E is connected.

NOTE: When selecting “automatic tuning” in set mode, pushing this switch is not necessary to tune the antenna. (p. 13)

8 CHANNEL SELECTOR [CHANNEL] (p. 8)

- ➔ Selects an operating channel within the selected channel group such as ITU channels.
 - User channels can be selected from 1 to 160 (max.) in sequence regardless of the channel group.
- ➔ Changes the operating frequency* after [CE] is pushed (while “▶” appears).
 - The changed frequency is not programmed in this way.

9 FUNCTION SWITCH [FUNC]

After pushing, activates the secondary functions of these switches:









- [RESET] . . . Deactivates external control such as from a DSC terminal unit when connected.
- [SQL] Starts and stops scan (p. 7).
- [SPEAKER] Activates intercom function (p. 17).
- [RX] Sets RF gain (p. 10).
- [TX] Selects transmit power (p. 9).
- [CE] Reprograms the channel name (p. 12).

NOTE: Function availability depends on version.

10 CLARITY CONTROL [CLARITY] (p. 10)

Shifts the receive frequency ± 150 Hz for clear reception of an off frequency signal.

11 KEYPAD

-  Enters the selected channel number (or frequency*) for direct channel selection. (p. 7)
- Stores a receive frequency into a user channel or ITU simplex channel when:
 - pushing [CE] (“▶” appears)
 - entering the desired frequency via the keypad
 - pushing and holding [RX] (p. 12)
- Adjusts the RF gain after pushing [FUNC] to reduce the receiver sensitivity. (p. 10)
-  Stores a transmit frequency into a user channel (except General versions) when:
 - pushing [TX] (“TX” flashes)
 - pushing [CE] (“▶” appears)
 - entering the desired frequency via the keypad
 - pushing and holding [TX] (p. 12)
- Selects the transmitter channel for cross channel operation (Europe versions only) when:
 - pushing [TX] (“TX” flashes)
 - entering the desired channel number via the keypad
- Selects the transmit output power after pushing [FUNC]. (p. 9)
-  Toggles the channel number input and frequency input.* (p. 8)
 - “▶” appears when frequency input* is selected.
 - The channel selector and keypad changes the frequency while “▶” appears.
- Clears the entered digit and retrieves the previous channel (or frequency*) while entering numbers. (p. 7)
- Enters the name programming condition, after pushing [FUNC], for changing the channel name. (p. 12)
-  Toggles the channel and frequency indications. (p. 6)
-  Enters “-” for ITU simplex channels. (p. 7)
-  Enter channel number with up to 4 or 5 digits when “▶” does not appear. (p. 7)
-  Enter the frequency with up to 6 digits* when “” appears. (p. 8)
- 

12 SQUELCH SWITCH [SQL] (p. 10)

- Activates the voice squelch function to reject undesired background noise while no signal is being received.
 - The squelch opens only when the received signal contains no voice or FSK components.
- Starts and stops the scan function after pushing [FUNC]. (p. 7)

13 NOISE BLANKER SWITCH [NB] (p. 10)

- Turns the noise blanker function on to remove pulse-type noise such as engine ignition noise.
 - “NB” appears when the function is turned on.

14 AGC OFF SWITCH [AGC] (p. 10)

- Deactivates the AGC function to receive weak signals blocked by strong adjacent signals.
 - “AGC” appears when the [AGC] switch is turned on (stands for AGC deactivated).

15 MODE SWITCH [MODE] (p. 9)

- Selects an operating mode temporarily. Available modes differ with version.
 - J3E (USB), H3E, J2B (AFSK), FSK, R3E and A1A (CW) modes are available.
 - The temporary mode is cleared and the previous mode appears when changing a channel.

16 OVEN INDICATOR (GMDSS version only)

- Internal high-stability crystal oscillator unit contains a temperature-compensating oven heater. This high-stability crystal oscillator improves frequency stability.
 - “STANDBY” appears when power to the main unit is turned off.

17 TRANSMIT FREQUENCY SWITCH [TX FREQ]

- (p. 9)
- Displays the transmit frequency and opens the squelch to check and monitor the transmit frequency.

18 2182 kHz SELECTION SWITCH

- [2182kHz • [RESET]] (p. iii)
 - Selects channel 0 (2182 kHz; distress call frequency).
 - The channel selector does not function when selecting channel 0.
 - Ignores external control and gives the front panel control priority when an external controller (NMEA format) is connected.

19 ALARM SWITCH [ALARM] (p. iii)

- Emits a distress alarm signal from the speaker.
- Transmits a distress alarm or alarm testing signal when pushed together with the [TX FREQ] switch.

 **NOTE:** General versions are not equipped with this [ALARM] switch.

*Some versions do not have frequency selection and frequency indication.

■ Main unit (controller detached)

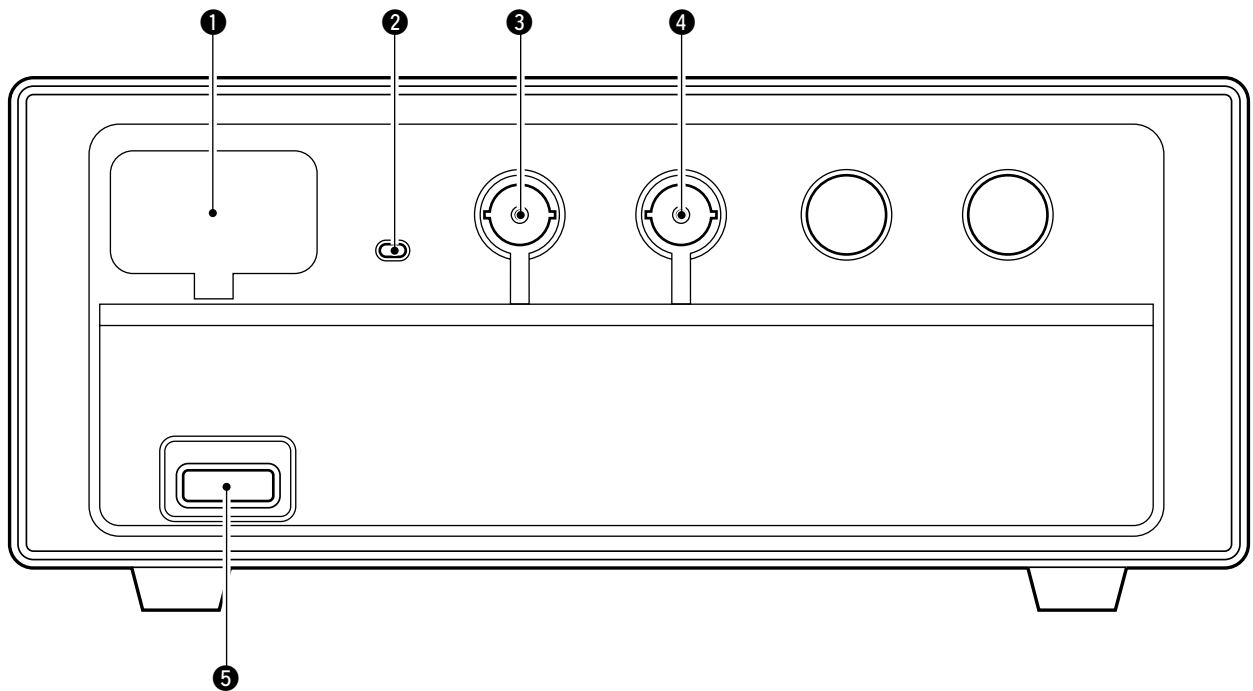

❶ RS-232C CONNECTOR (p. 18)

Connects the IC-M710RT to a PC via an RS-232C cable for remote control of transceiver function using the optional RS-710RT software.

❷ POWER INDICATOR

Appears while power is turned on.

❸ CONTROLLER CONNECTOR

Connects the main body of the IC-M710RT to the front panel (controller) when detached from the main body.

❹ CONTROLLER CONNECTOR (pgs. 16, 17)

Same as above.

❺ POWER SWITCH

Same function as the power switch ([POWER]) on the front panel.

- Only available on the Europe and GMDSS versions.

◇ HM-120 microphone keys

The "P" key on the HM-120 HAND MICROPHONE can be set to function as the [MODE], [NB], [AGC], [SQL] or [TUNE] keys on the remote controller. (The ▲▼ keys function the same as the [CHANNEL] selector). Also, using set mode (p. 15) these keys can be deactivated if desired.

While pushing [P] on the microphone and the switch on the remote controller whose function you want to assign (see above), turn power ON.

- Repeat this to assign a different key.

■ Display

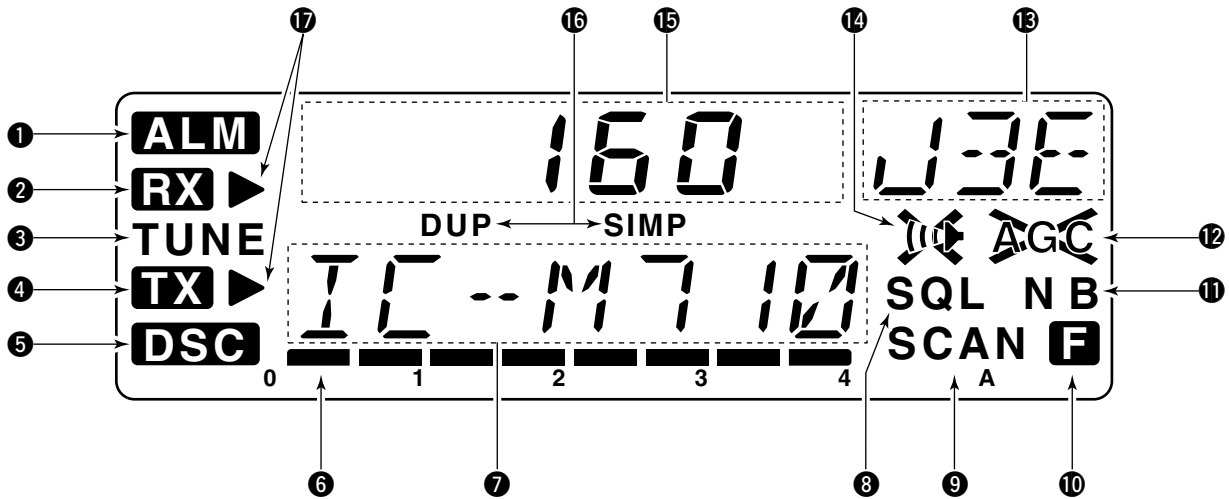

- 1 ALARM INDICATOR** (p. iii)
Appears when the alarm function is activated such as for an alarm test or distress alarm transmission.
• Not available in General version.
- 2 RECEIVE INDICATOR** (p. 10)
Appears while receiving and when the squelch is open.
- 3 TUNE INDICATOR** (p. 9)
Flashes while the connected antenna tuner, such as Icom's AT-130, is being tuned.
• Tuning starts when transmitting on a new frequency or pushing the [TUNE] switch.
- 4 TRANSMIT INDICATOR**
➤ Appears when transmitting. (p. 9)
➤ Flashes when the [TX] key is pushed for transmit frequency programming. (p. 12)
- 5 DSC INDICATOR** (p. iii)
Appears when an optional GM-110DSC DSC TERMINAL UNIT controls transceiver functions.
• The GM-110DSC can be connected to GMDSS versions only.
- 6 S/RF METER**
➤ Shows the relative received signal strength while receiving.
➤ Shows output power while transmitting.
➤ Shows antenna current level when an optional AT-130E HF ANTENNA TUNER is connected (Europe versions only).
- 7 CHANNEL/VFO INDICATOR**
➤ Shows the pre-programmed channel name (alphanumeric) during channel indication. (p. 6)
• Some versions have no channel name function and show receive frequency instead.
➤ Shows the transmit frequency during frequency indication. (p. 6)
➤ Shows transmit channel number during cross channel operation (Europe versions only). (p. 11)
- 8 SQUELCH INDICATOR** (p. 10)
Appears when the squelch is on.
- 9 SCAN INDICATOR** (p. 7)
Appears when the scan function is in use.
• The scan function is not available on some versions.
• Pushing [FUNC] then [SQL] starts and stops scan.
- 10 FUNCTION INDICATOR**
Appears when the [FUNC] switch is pushed.
- 11 NOISE BLANKER INDICATOR** (p. 10)
Appears when the [NB] switch is turned on.
- 12 AGC OFF INDICATOR** (p. 10)
Appears when the [AGC] switch is pushed to indicate the AGC function is deactivated.
- 13 MODE READOUT**
Shows the selected operating mode (type of emission).
- 14 SPEAKER OFF INDICATOR**
Appears when the [SPEAKER] switch is pushed to indicate the front panel speaker is deactivated.
- 15 CHANNEL READOUT**
➤ Shows the selected channel number during channel indication. (p. 6)
➤ Shows the receive frequency during frequency indication. (p. 9)
- 16 SIMPLEX/DUPLEX INDICATORS**
These appear to show whether the selected channel is simplex or duplex.
- 17 FREQUENCY INDICATORS** (p. 8)
Appear when the frequency entry condition* is selected for frequency selection.
• The [CE] key toggles the indicator ON and OFF.
* Some versions have no frequency entry condition.

Selecting a channel

The transceiver has 160 user channels and ITU channels. However, the number of user channels can be optionally restricted and ITU channels are not available with some versions.

NOTE: When channel 0 and/or 2182 kHz is selected with the [2182KHz] switch, channel selection is NOT possible. In such cases, push [2182KHz] in advance.

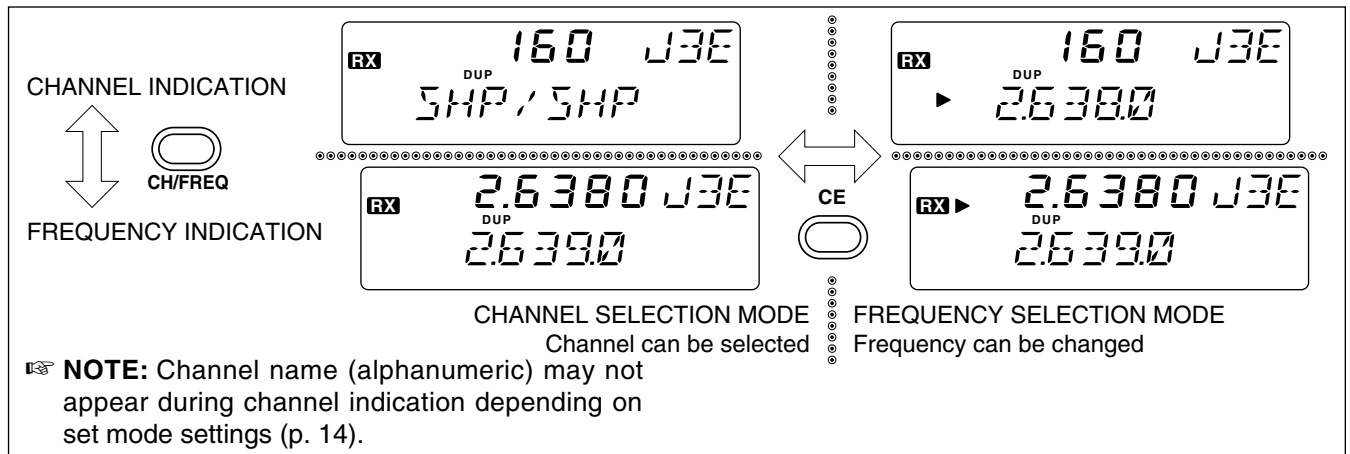

Using the channel selector

The transceiver has two large controls for group selection and channel selection. The [GROUP] selector changes channels in 20 channel increments and selects ITU channel groups*; and the [CHANNEL] selector selects each channel.

① Make sure no "▶" indicator appears on the display.

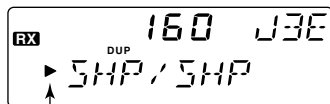

If appears, push [CE] to delete it.

② Rotate the [GROUP] selector to select the desired channel group as shown at right and/or below.

③ Rotate the [CHANNEL] selector to select the desired channel.

[EXAMPLE]: Selection with the [GROUP] selector

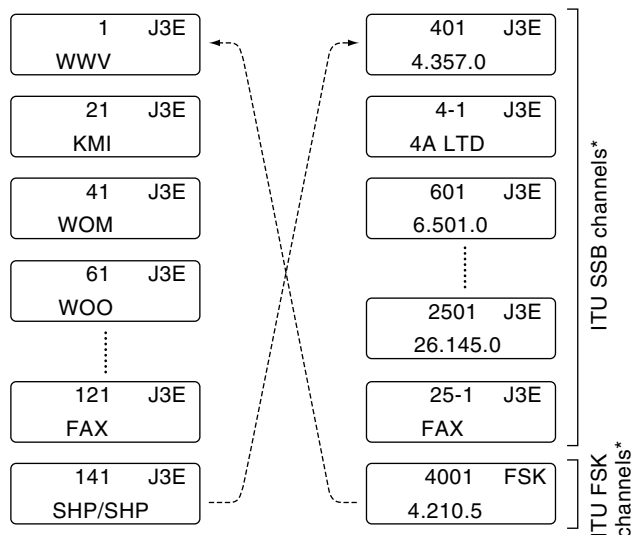

*All ITU channels are not available with some versions and ITU FSK channels can be hidden using set mode. (p. 13)

CHANNEL GROUPS

CHANNEL NO.	DESCRIPTION	CHANNEL NO.	DESCRIPTION
1 to 160	User channels* ¹	1601 to 1656	16 MHz ITU duplex channels
401 to 427	4 MHz ITU duplex channels	16-1 to 16-9	16 MHz ITU simplex channels
4-1 to 4-9	4 MHz ITU simplex channels	1801 to 1815	18 MHz ITU duplex channels
601 to 608	6 MHz ITU duplex channels	18-1 to 18-9	18 MHz ITU simplex channels
6-1 to 6-9	6 MHz ITU simplex channels	2201 to 2253	22 MHz ITU duplex channels
801 to 832	8 MHz ITU duplex channels	22-1 to 22-9	22 MHz ITU simplex channels
8-1 to 8-9	8 MHz ITU simplex channels	2501 to 2510	25 MHz ITU duplex channels
1201 to 1241	12 MHz ITU duplex channels	25-1 to 25-9	25 MHz ITU simplex channels
12-1 to 12-9	12 MHz ITU simplex channels	4001 to 25040	ITU FSK duplex channels* ²

*1[GROUP] selector changes in 20 channels steps.

*2SITOR use—no group separation.

◇ **Using the keypad**

Direct channel selection via the keypad is available for quick channel selection.

- ① Make sure “▶” does not appear on the display.
 - If it appears, push [CE] to delete it.
- ② Enter the desired channel number via the keypad.
 - A user channel is selected when channel 1–160 is input (max. number may be optionally restricted).
 - An ITU SSB channel is selected when channel numbers higher than 401 are input (not available for some versions).
 - An ITU FSK channel is selected when channel numbers higher than 4001 are input (not usable according to set mode setting).
 - The “-” key can be used for selecting an ITU simplex channel.
- ③ Push [RX] to select the entered channel.

[EXAMPLE]: Selecting channel 153

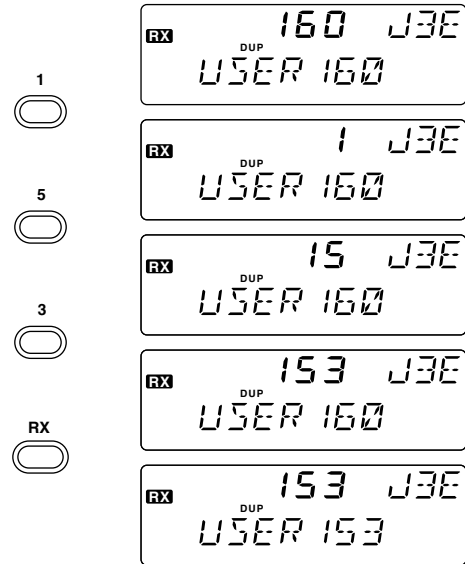

◇ **Using scan functions**

(Some versions do not have these functions)

The transceiver has automatic channel or frequency change capability (scan function). There are 3 types of scan functions available to suit your needs.

Channel scan

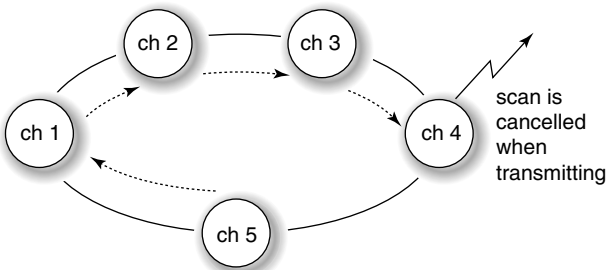

Channel resume scan

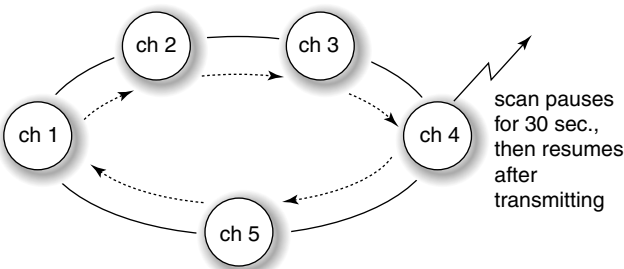

Programmed scan (optional)

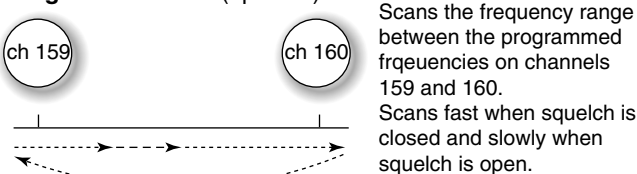

Channel scan and channel resume scan increase channels within a 5 channel range such as ch 1 to ch 5, ch 156 to ch 160, etc. in user channels; or all channels in the group of ITU channels.

Programmed scan (optional) changes frequencies within the frequency range between user channels 159 and 160.

Scan selection is available in set mode. See p. 14 for scan selection.

SCAN OPERATION

- ① Select your desired channel group with the [GROUP] and [CHANNEL] selector.
 - Or use the keypad and [CE] key for direct selection.
 - This operation is not necessary for programmed scan.
- ② Push [SQL] to turn OFF the squelch function if programmed scan is selected.
- ③ Push [FUNC] then [SQL] to start the scan.
- ④ To stop the scan, repeat step ③ again.
 - [CHANNEL] rotation and some other switches also stop the scan.

3 SELECTING A CHANNEL/FREQUENCY

■ Selecting a frequency

The transceiver has 0.5 to 30.0 MHz general coverage receive capability with 100 Hz resolution. The receive frequency can be changed instantly, independent of the transmit frequency.

NOTE: The selected frequency is used for temporary receiving (transmitting is not available). This frequency is cleared once the channel is changed. If you want to program a frequency, refer to p. 12.

◇ Using the channel selector

- ① Select a channel which is programmed near the frequency you want to receive.
- ② Push the [CE] key to select frequency selection mode.
 - “▶” appears on the display.
- ③ Rotate the [CHANNEL] selector to change the frequency.
- ④ To return to the previous frequency, push [CE].
 - “▶” disappears and the previous frequency or channel name appears.

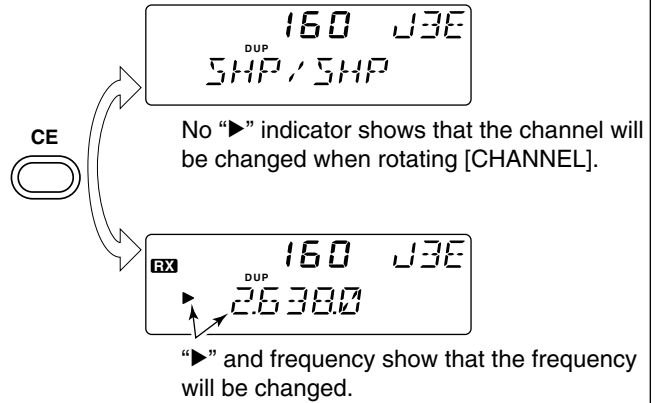

◇ Using the keypad

CAUTION: A frequency can be entered into a user channel or ITU simplex channel by pushing the [RX] key. However, when pushing and holding the [RX] key after entering a frequency, the previously programmed contents are erased and cannot be retrieved. Therefore, keypad entry should be used only on spare channels.

- ① Select the memory channel to be used for general coverage use.

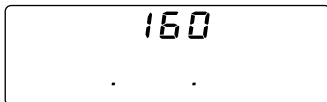

No frequency programmed channel for general coverage use.
(mode and channel name do not appear)

- ② Push [CE] to select frequency selection mode.
- ③ Enter the desired frequency with 5 or 6 digits.
- ④ Push [RX] to input the frequency.
 - **Do not hold [RX]** for more than 0.5 sec., otherwise the frequency will be programmed into the channel.

[EXAMPLE]: Setting 12.3450 MHz

Select non frequency programmed channel.

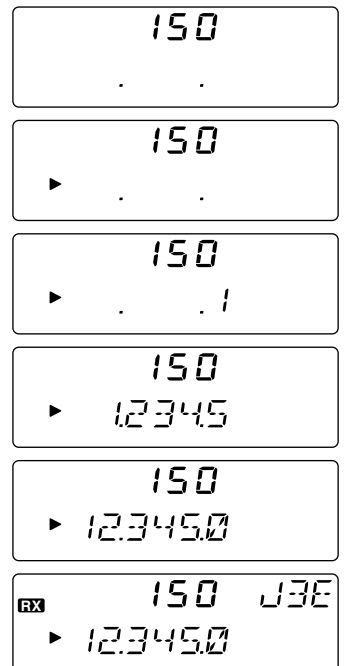
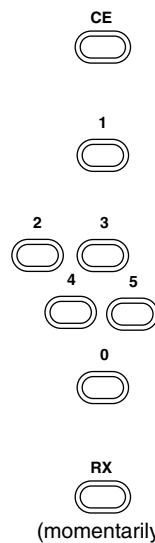

After temporarily receiving.

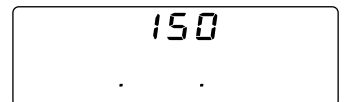

■ Basic voice receive and transmit

- ① Check the following in advance:
 - ➔ Microphone is connected.
 - ➔ [SPEAKER] switch is turned off.
 - ➔ [SQL] switch is turned off.
 - ➔ [CLARITY] control is set to the center position.

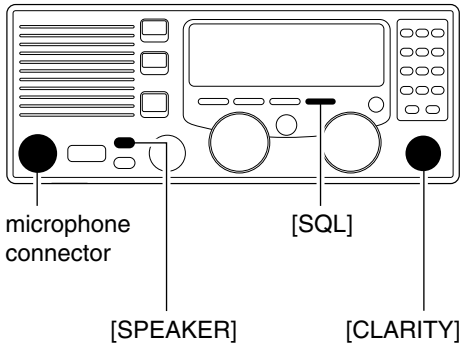

- ② Select the desired channel to be received with the [GROUP] and [CHANNEL] selectors.
 - When receiving a signal, the S-meter shows the signal strength.

- ③ Adjust [VOLUME] to the desired audio level when receiving a signal.
- ④ Push [MODE] to select the desired operating mode, if the received signal is in a different mode.
- ⑤ Push [TUNE] to tune the antenna tuner, if connected.
 - This operation is not necessary when “automatic tuning” is selected in set mode (p. 13).
- ⑥ To transmit on the channel, push and hold the PTT switch on the microphone.
 - “TUNE” flashes for 1 to 2 sec. for the first transmission on a channel when an antenna tuner is connected.
- ⑦ After the flashing stops, speak into the microphone at your normal voice level.
 - The RF meter shows the output power according to your voice level.
- ⑧ Release the PTT switch to return to receive.

■ Functions for transmit

◇ Transmit frequency check

When “DUP” appears on the display such as for a ship-to-shore channel, the transmit frequency differs from the receive frequency.

In such cases, the transmit frequency should be monitored before transmitting to prevent interference to other stations.

Push and hold [TX FREQ] to monitor the transmit frequency.

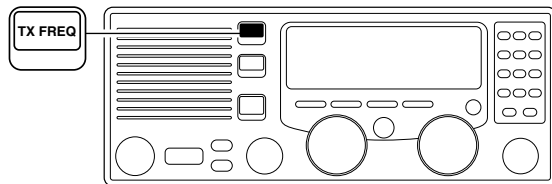

- The display shows the transmit frequency.

◇ Transmit power selection

The transceiver has 3 selectable output powers.* High power allows longer distance communications and low power reduces power consumption.

*Only 2 selectable output powers are available with some versions. In this case, level 1 stands for 60 W (the same as level 2).

NOTE: Low power setting affects all channels except the 2182 kHz emergency channel.

NOTE: Although power selection appears possible with GMDSS versions, only high power is available.

- ① Push [FUNC] then [TX] to call up the following display.

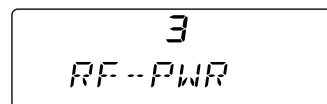

- ② Rotate the [CHANNEL] selector to select high or low output power.

- 3 : high power (150 W PEP)
- 2 : middle power (60 W PEP)
- 1 : low power (20 W PEP)

- ③ Push [FUNC] or [CE] to return to the previous display.

■ Functions for receive

◇ Squelch function

The squelch function detects signals with voice components and squelches (mutes) unwanted signals such as unmodulated beat signals. This provides quiet standby.

When you need to receive weak signals, the squelch should be turned off.

Push [SQL] to toggle the function on and off.

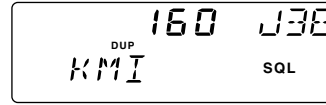

- “SQL” appears when the squelch function is turned on.

◇ Noise blanker

The noise blanker function reduces pulse type noise such as that coming from engine ignitions.

The noise blanker may distort reception of strong signals. In such cases, the noise blanker should be turned off.

Push [NB] to toggle the function on and off.

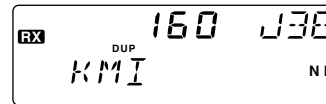

- “NB” appears when the noise blanker function is turned on.

◇ AGC off function

The receiver gain is automatically adjusted according to received signal strength with the AGC (Automatic Gain Control) function to prevent distortion from strong signals and to obtain a constant output level.

When receiving weak signals with adjacent strong signals or noise, the AGC function may reduce the sensitivity. In this situation, the AGC function should be deactivated.

Push [AGC] to toggle the function on and off.

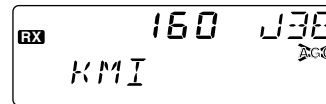

- “AGC” appears when the AGC function is deactivated.

◇ RF gain setting

The receiver gain can be reduced with the RF gain setting. This may help to remove undesired weak signals while monitoring strong signals.

Usually, the AGC function reduces the RF gain according to the receive signal strength and these weak signals are removed. However, during no signal reception, these weak signals may not be heard.

In such cases, the RF gain may be useful for setting a minimum level at which to hear signals.

- ① Push [FUNC] then [RX] to call up the following display.

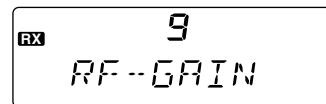

- ② Rotate the [CHANNEL] selector to set the desired minimum cutting level.
 - “0” to “9” are available.
 - S-meter shows the minimum permitted level.
- ③ Push [FUNC] or [CE] to exit the RF gain display.

◇ Clarity control

Voice signals received from other stations may be difficult to receive. This may sometimes happen if a station is transmitting slightly off frequency. In such cases, compensate the receive frequency only, using the [CLARITY] control.

Adjust [CLARITY] to improve the audio signal.

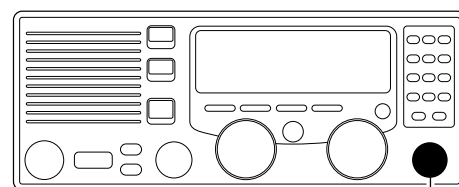

[CLARITY]

■ CW operation

The transceiver has the following CW keying features selectable in set mode as described on page 15.

- ➔ Full break-in (receiving is possible while transmitting)
- ➔ Delay keying (automatic transmission with keying)
- ➔ Off (manual transmission is necessary before keying)

- ① Connect a CW keyer or an external electronic keyer to the ACC(1) socket as shown at right.
- ② Select the desired channel to operate CW mode.
- ③ When the selected channel is not in A1A mode, push [MODE] one or more times to select "A1A."
- ④ Operate the CW keyer to transmit a CW signal.

NOTE: CW mode is not available in some versions and CW narrow can be selected in set mode (p. 14) when an optional filter is installed (already built-in to the GMDSS versions).

CW key connection

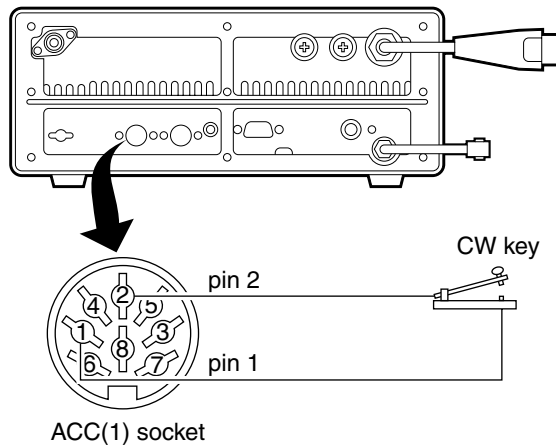

■ FSK operation

The transceiver has FSK and J2B modes for FSK operation—use FSK when using the built-in oscillator; use J2B when using an AFSK terminal unit.

- ① Connect an FSK terminal unit as shown at right.
- ② Select the desired channel.
 - FSK ITU channel group, ch 4001 to ch 25040, are available depending on version.
- ③ Push [MODE] one or more times to select the type of emission, "FSK" or "J2B."
- ④ Operate the FSK terminal unit.

NOTE:

- ➔ FSK shift frequency and FSK polarity can be adjusted in set mode (p. 14).
- ➔ Some transceivers may operate 1.7 kHz higher than the IC-M710RT's J2B mode even when the same displayed frequencies are in use.

FSK terminal unit connection

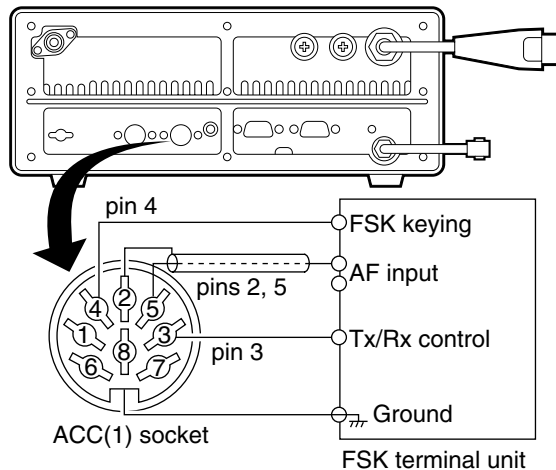

■ Cross channel operation*

Cross channel operation is available with some versions to operate different channels for receive and transmit.

- ① Select the desired channel for receive.
 - ITU simplex channels cannot be used.
- ② Push [TX], then select the desired channel for transmit.
 - "TX" flashes after pushing [TX].
- ③ Push [TX] again to stop the blinking.
- ④ Operate the transceiver normally.
- ⑤ Change the channel to clear the cross channel setting.

*This function is available for Europe versions only.

Cross channel operation example

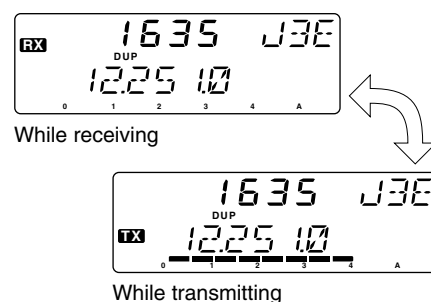

■ Programming a frequency

The IC-M710RT has up to 160 user-programmable channels each with channel name capability of up to 7 alphanumeric characters.

NOTE: ITU simplex channels can be programmed as well as user channels. However, transmit frequencies cannot be programmed as it is not necessary.

◇ Receive frequency

- ① Select the desired channel to be programmed.
 - Channels 1 to 160 (maximum) are programmable.
- ② Push [CE] to select frequency selection mode.
 - “▶” and frequency appear on the display.
- ③ Enter the desired frequency via the keypad—5 or 6 digits.
 - Or rotate the [CHANNEL] selector to change the frequency.
- ④ To change the operating mode (type of emission), push [MODE] one or more times.
- ⑤ Push and hold [RX] for 1 sec. to program the user channel.

Push [CE]

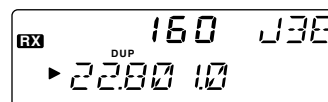

Frequency and “▶” appear.

Set frequency

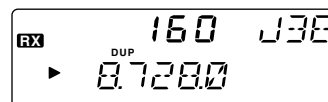

Use keypad or channel selector.

Push and hold [RX]

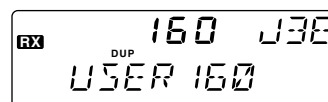

Programming is completed.

◇ Transmit frequency

(Not applicable for General versions)

- ① Select the desired user channel to be programmed.
- ② Push [TX].
 - “TX” flashes.
- ③ Push [CE] to select frequency selection mode.
 - “▶” and frequency appear on the display.
- ④ Enter the desired frequency via the keypad with 5 or 6 digits.
 - The [CHANNEL] selector cannot be used.
- ⑤ Push and hold [TX] for 1 sec. to program.
- ⑥ Push [TX] to stop “TX” from flashing.

Push [TX]

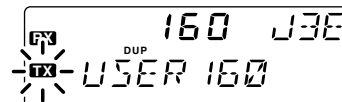

“TX” flashes.

Push [CE]

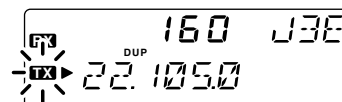

Push and hold [TX]
after entering a
frequency

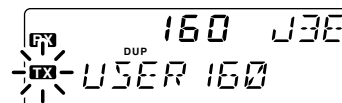

◇ Channel names

- ① Select the desired user channel to be programmed.
- ② Push [CH/FREQ] to select channel indication.
- ③ Push [FUNC] then [CE].
 - The channel name (alphanumeric) readout flashes.
- ④ Rotate the [GROUP] selector for cursor position and the [CHANNEL] selector for name content.
 - To return to the previous message, push [CE].
- ⑤ Push and hold [RX] to program the name.
 - Flashing stops.

Push [FUNC]
then [CE]

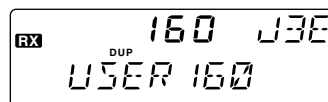

“TX” flashes.

Rotate [GROUP]
and [CHANNEL]
to select cursor and
character



Push [RX]

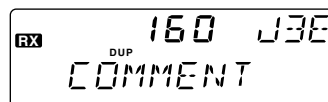

■ Set mode operation

Set mode operation is used for programming infrequently changed values or conditions of functions.

NOTE: Some of the set mode items described in this section are not available on some transceiver versions.

- ① Push [POWER] to turn power off, if necessary.
- ② While pushing [FUNC] + [1], push [POWER] to turn power on and enter set mode.
- ③ Rotate the [GROUP] selector to select the desired item.
- ④ Rotate the [CHANNEL] selector to set the values or conditions for the selected item.
- ⑤ Turn power off and on again to exit set mode.

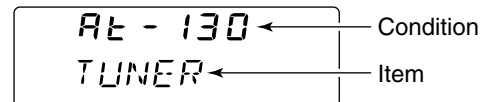
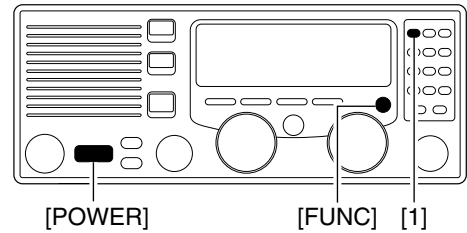

■ Set mode contents

<p>(1) FSK ITU channels FSK ITU channels appear as a group between the ITU 25 MHz band and user channels. This FSK channel group can be hidden for voice communication only.</p>	<div style="border: 1px solid black; padding: 5px; text-align: center;"> OFF SITOR </div>	<p>FSK channels don't appear (no SITOR operation). <i>(default)</i></p>
<p>(2) Connected antenna tuner The transceiver has several tuner control systems for use with an optional Icom antenna tuner. Select the condition depending on the connected antenna tuner.</p> <p>NOTE: Internal switch selection may be required when using a non-Icom tuner (p. 23).</p>	<div style="border: 1px solid black; padding: 5px; text-align: center;"> At - 130 TUNER </div> <div style="border: 1px solid black; padding: 5px; text-align: center; margin-top: 5px;"> At - 120 TUNER </div> <div style="border: 1px solid black; padding: 5px; text-align: center; margin-top: 5px;"> AH - 3 TUNER </div>	<p>AT-130 <i>(default)</i></p> <p>AT-120</p> <p>AH-3</p>
<p>(3) Automatic tuning condition When the optional AT-130 or AT-130E automatic antenna tuner is connected, tuning can be started automatically without the [TUNE] switch, for instant operation.</p> <p>If manual tuning is required, this automatic operation can be deactivated.</p>	<div style="border: 1px solid black; padding: 5px; text-align: center;"> ON AUT - TUN </div> <div style="border: 1px solid black; padding: 5px; text-align: center; margin-top: 5px;"> OFF AUT - TUN </div>	<p>Tuning starts when pushing [PTT] on a new frequency.</p> <p>Tuning starts only when [TUNE] is pushed. <i>(default)</i></p>

6 SET MODE

(4) Scan type selection (scan-type only)

This item selects one of the following scan functions.

Channel scan and channel resume scan search 5 channels around a user selected channel or search all ITU channels in the band when an ITU channel is selected.

Programmed scan (optional) searches signals within the frequency range and activates slowly while squelch is open and fast while squelch is closed.

CH
SC--TYPE

Channel scan
Scan is canceled when transmitting.
(default)

CH--RES
SC--TYPE

Channel resume scan
Scan pauses when squelch opens, then resumes after 10 sec.

Pro
SC--TYPE

Channel resume scan
Scan operates over the frequency range.
(optional)

(5) Scan speed

This item adjusts the scan speed (rate at which channels are searched). The scan speed can be set from 1 to 10 with "1" being the fastest and "10" being the slowest.

1
SC--SPD

Fastest scan speed

(default: 4)

10
SC--SPD

Slowest scan speed

(6) Channel name and frequency

The lower half of the display can be set to display a programmable channel name or a receive frequency according to operator needs.

CH--Co
CH--DISP

Channel number and channel name
—alphanumeric
(default)

CH--Fr
CH--DISP

Channel number and frequency

(7) CW/FSK narrow filter

This item selects the passband width for A1A (CW), FSK or J2B mode.

NOTE: When "on" is selected without optional filter installation, the Marine and General versions do not function in these modes. The GMDSS versions can use "on" as standard.

OFF
NAR--FIL

Passband:
2.3 kHz/−6 dB
(default)

ON
NAR--FIL

Passband:
500 Hz/−6 dB (Gene/Marine)
350 Hz/−6 dB (GMDSS)

(8) FSK shift frequency

Several shift frequencies (the difference between the mark and space frequency) are used for FSK operation. This item allows you to select a shift frequency for almost any FSK system.

170
FSK--SFT

Shift frequency:
170 Hz
(default)

425
FSK--SFT

Shift frequency:
425 Hz

850
FSK--SFT

Shift frequency:
850 Hz

(9) FSK polarity
 Normal and reverse polarities are available for FSK operation. This item allows you to select one of these polarities.

“FSK-REV off” (normal):
 key open (mark); key close (space)

“FSK-REV on” (reverse):
 key open (space); key close (mark)

	OFF FSK--REV	FSK normal <i>(default)</i>
	ON FSK--REV	FSK reverse

(10) CW break-in
 The CW break-in function (in A1A mode) toggles transmit and receive with CW keying. Full break-in allows you to receive signals between transmitted keying pulses during CW transmission. Semi break-in allows you to mute receiving until keying stops with some delay time.

	FULL CW--BKIN	Full break-in Automatic keying without delay time <i>(default)</i>
	DELAY CW--BKIN	Semi break-in Automatic keying with delay time
	OFF CW--BKIN	OFF Manual transmission necessary for keying

(11) Microphone keys
 This item activates/deactivates the keys on the HM-120 HAND MICROPHONE (“P”, “▲” and “▼”). Refer to p. 4 to program the “P” key.

	ON MIC--KEY	Microphone keys activated. <i>(default)</i>
	OFF MIC--KEY	Microphone keys deactivated.

(12) Remote control busy timer
 This sets the time for which operation of one remote controller is inhibited while operating the other. The timer can be set from 0 to 180 sec.

	5 BUSY--T	Busy timer: 5 sec. <i>(default)</i>
--	--------------	--

(13) ID number setting for remote control
 When connecting an external controller such as a personal computer, 2-digit ID codes are required to access the transceiver. The IC-M701RT adopts NMEA0183 format and uses a “proprietary sentence” for remote control. ID 01 to 99 are available.

	03 REMT--ID	NMEA ID: 03 <i>(default)</i>
--	----------------	---------------------------------

(14) Remote control input terminal
 Remote control signals can be input via the [RS-232C] socket or [CLONE] jack.

	d-Sub REMT--IF	[REMOTE] socket <i>(default)</i>
	Pin REMT--IF	[CLONE] jack

■ Supplied accessories

DC power cable (OPC-568)	1
Mounting bracket	1
Bracket knobs (8820000170)	4
CONNECTORS	
DIN connector (8-pin for ACC1)	1
DIN connector (7-pin for ACC2)	1
Tuner connector (56100000150)	1
Pins for tuner connector (6510019030)	4
DIN connector cover (GMDSS only—attach to the ACC sockets)	1
NUTS AND BOLTS	
Allen bolt (M6 × 50)	4
Self-tapping screws (M6 × 30)	4
Nuts (M6; use 2 pcs. for each bolt)	8
Flat washers (M6)	8
Spring washers (M6)	4
Self-tapping screws (3.5 × 30 for mic. hanger)	2
FUSES	
FGB 30 A (rear panel)	2
FGB 5 A (internal)	2

RC-21 (REMOTE CONTROLLER) ACCESSORIES

Microphone (HM-120*)	1
Microphone hanger*	1
DC power cable (OPC-775)	1
Mounting bracket	1
Bracket knobs	2
NUTS AND BOLTS	
Self-tapping screws* (3.5 × 30 for mic. hanger)	2
Flat washers (M5)	2
Nuts (M6; use 2 pcs. for each bolt)	10
Spring washers (M6)	5
Allen bolt (M6 × 50)	5
Self-tapping screws	5
Flat washers (M6)	10
Ground lug (M5)	1
FUSES	
FGB 30 A (rear panel)	2
FGB 5 A (internal)	2
*Depends on version.	

■ Attaching 1 remote controller

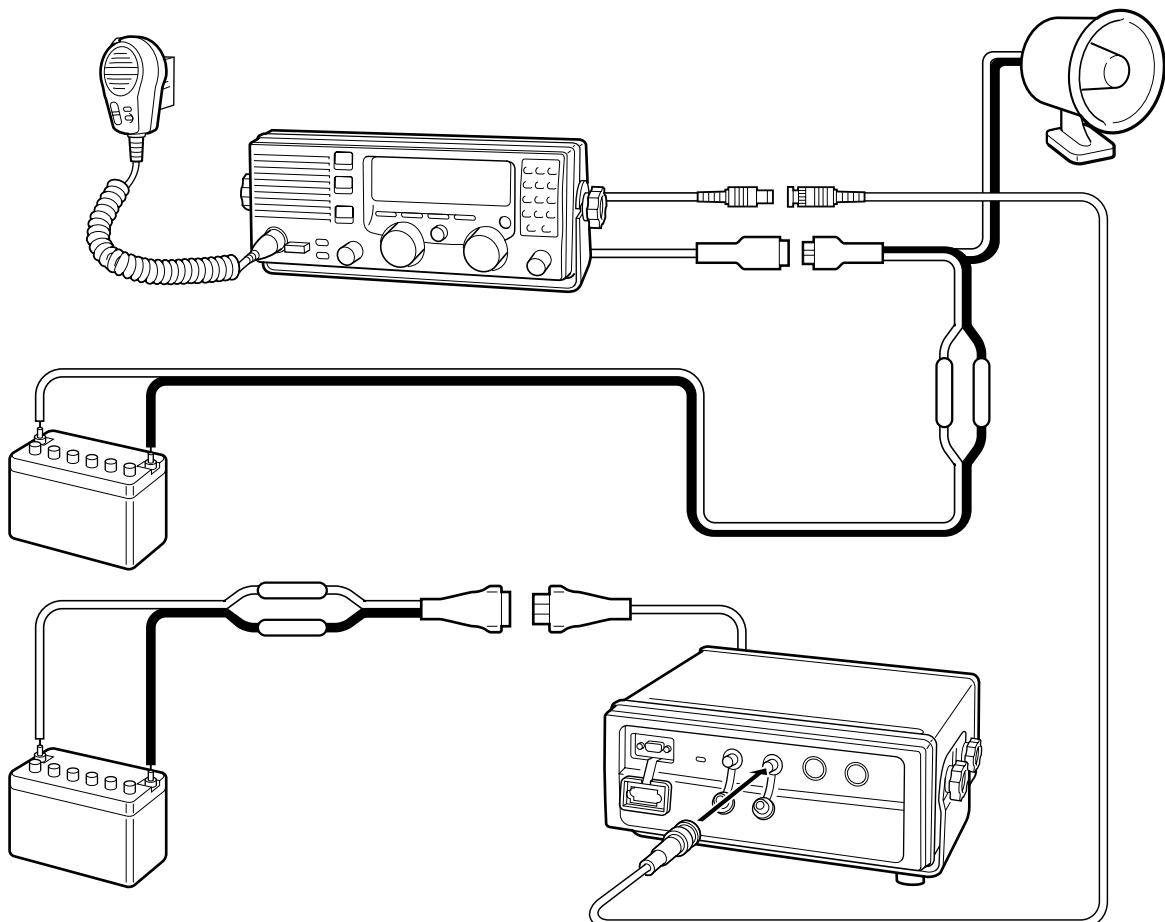

■ Attaching 2 remote controllers

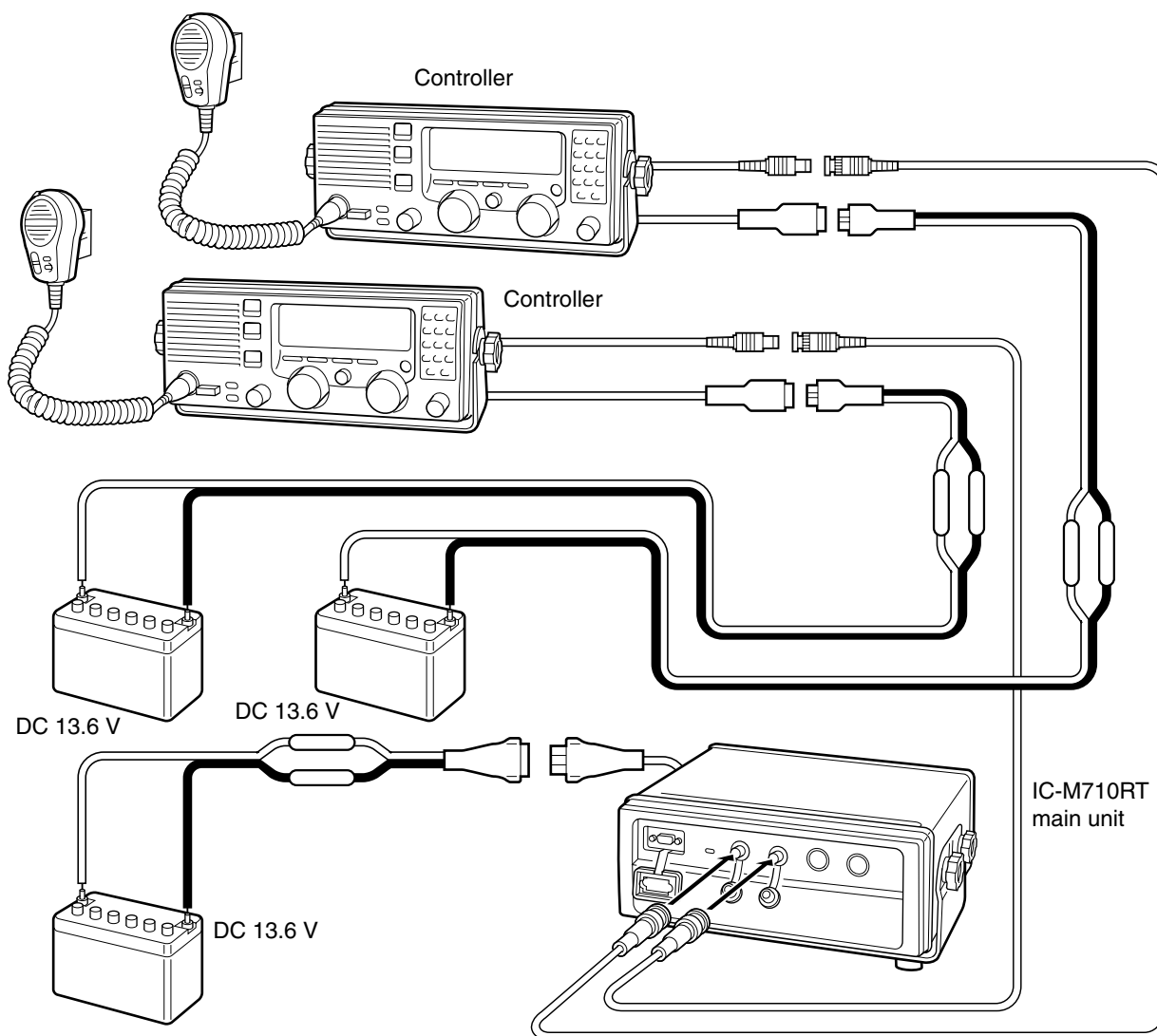

◇ Set ID number

The ID numbers for each remote controller must be set properly for the intercom function to operate (see right).

- ① While pushing [FUNC] + [-], push [POWER].
 - Channels 1 to 160 (maximum) are programmable.
- ② Rotate the channel selector to select the desired unit ID number if desired.
 - Default ID's are No. 1 for the supplied remote controller and No. 2 for an optional remote controller.
- ③ Push [POWER] turn the power OFF.

◇ Intercom operation

The intercom function allows you to communicate between two remote controllers.

- ① Push [FUNC] and then push [SPEAKER] to turn the intercom function ON.
 - "INCOM" blinks and beeps are emitted; the blinking continues until the intercom function is cancelled.
 - Push [FUNC] to cancel the intercom function.
- ② Push and hold the [PTT] switch on the microphone and speak into the microphone at a normal voice level.
 - The display stops blinking and the ID number of the remote controller being used to transmit appears on both remote controller displays.
 - When no ID appears, operators at either remote controller are free to transmit.
 - When neither remote controller is used to transmit for 30 sec. the intercom function is automatically cancelled.
- ③ Push [FUNC] to end intercom operation.

■ Attaching 2 remote controllers and a PC

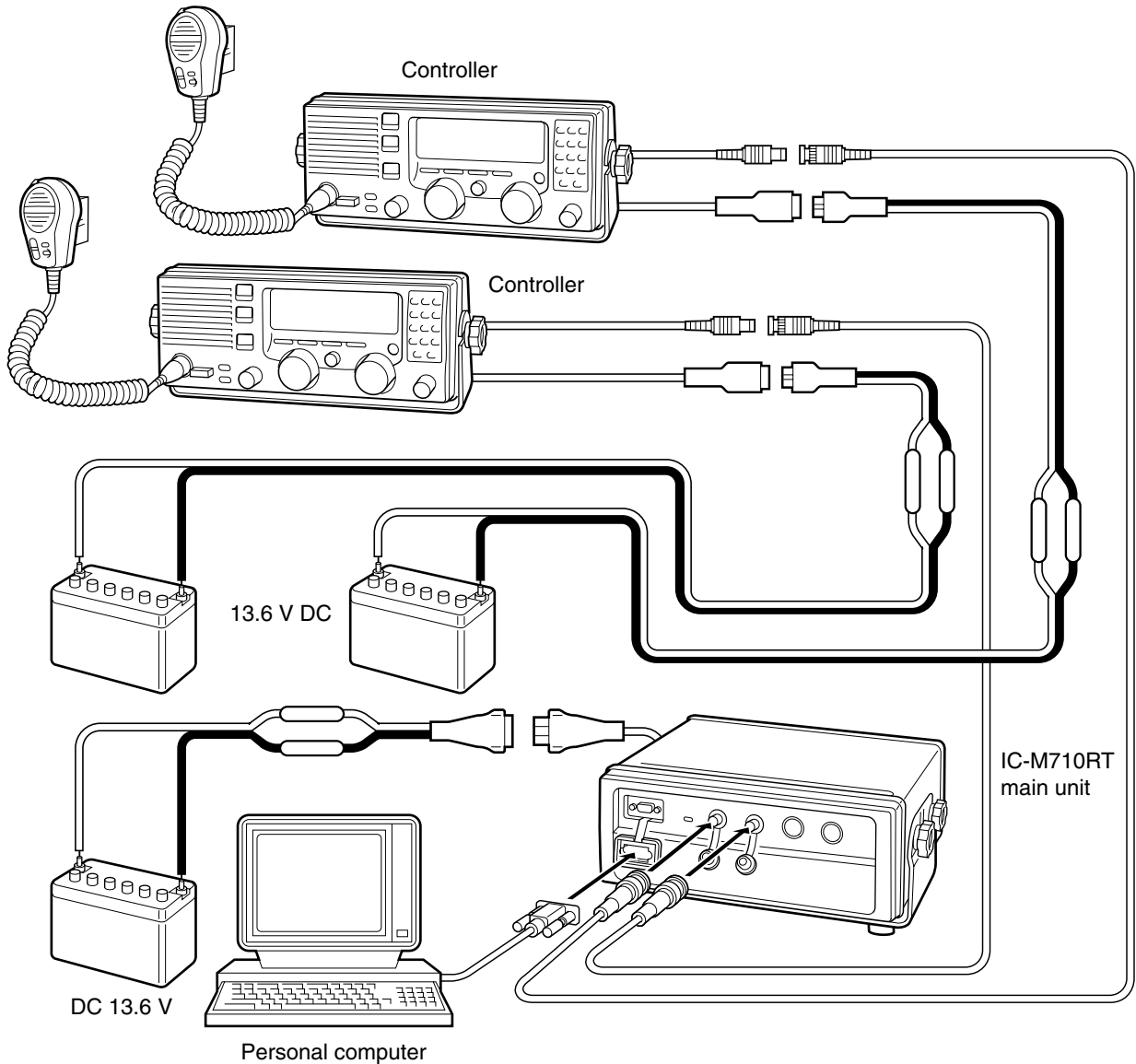

■ Notes for remote control

- ☞ When more than 1 controller (incl. PC) is connected, the controller (or PC) being operated at any given time has priority.
- ☞ When more than 1 controller (incl. PC) is connected, the controller (or PC) not being operated is inhibited for a specified time after another controller (or PC) is operated. This time can be programmed by your dealer. The default inhibit time is 5 sec.
- ☞ When more than 1 controller (incl. PC) is connected, operating one controller automatically updates settings on the other controller (PC).
- ☞ Volume adjustment is independently controlled by each remote controller (PC).
- ☞ The optional RS-M710RT software allows you to program memory channels not available through regular IC-M710RT operation. Refer to the RS-M710RT online help for details.
- **CAUTION:** The rear of any connected remote controller must be properly grounded. We suggest using a wide copper ribbon. (p. 22)

■ Connections on rear panel

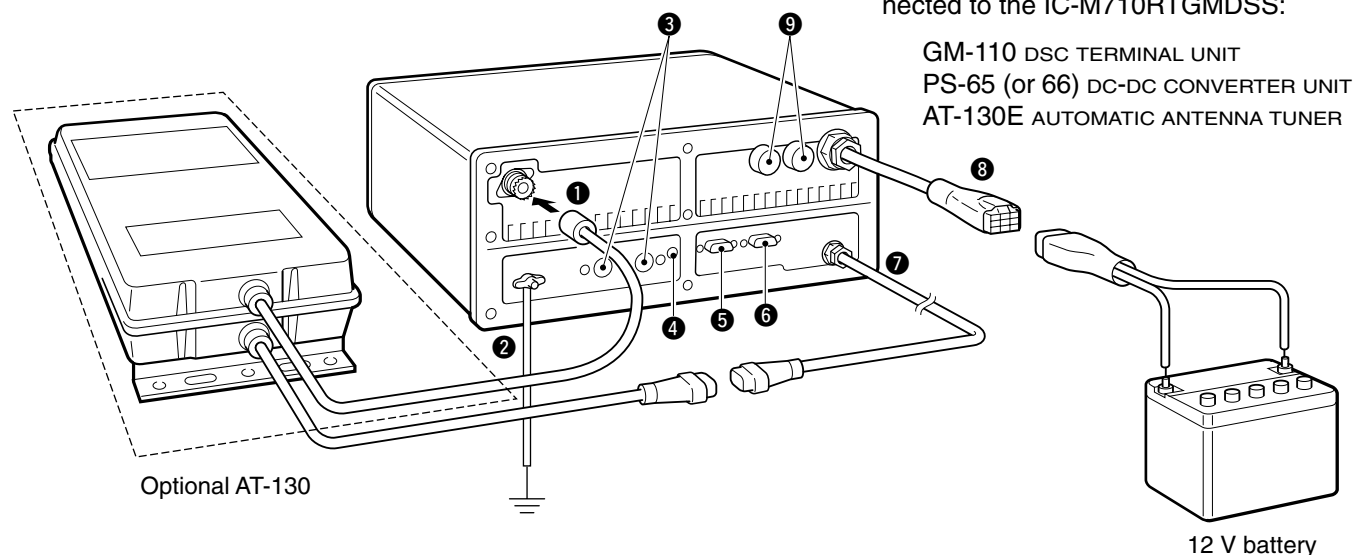

➤ **NOTE:** To meet European GMDSS regulations, the following must be connected to the IC-M710RTGMDSS:

1 ANTENNA CONNECTOR (p. 23)

Connects a 50 Ω HF band antenna with a 50 Ω matched coaxial cable and a PL-259 plug.

2 GROUND TERMINAL

IMPORTANT! Connects a ship's (or vehicle's) ground. See p. 22 for details.

3 ACC(1) and ACC(2) SOCKETS

See p. 20 for details.

4 CLONE JACK

For Dealer use only.

5 DSC or REMOTE SOCKETS (p. 21)

- DSC socket for GMDSS versions—connects an optional GM-110DSC DSC TERMINAL UNIT.
- REMOTE socket for Marine and General versions.

6 MOD/AF SOCKET (GMDSS versions only)

Connects an external terminal unit.

7 TUNER RECEPTACLE

Connects a control cable to an optional AT-130 or AT-130E ANTENNA TUNER. A female connector is supplied for connection.

8 DC POWER RECEPTACLE

Connects to a regulated 12–16 V DC power source such as a 12 V battery or DC power supply using the supplied DC power cable.

➤ **CAUTION: DO NOT** connect to a 24 V battery. This will damage the transceiver.

9 FUSE HOLDERS

Hold two 30 A fuses for +ve and –ve terminals. Replace both fuses when one fuse is blown.

■ Connector information

ACC(1)*	PIN	PIN NAME	DESCRIPTION	SPECIFICATIONS
	1	CWK	CW and FSK keying input.	Input level: Less than 0.6 V for transmit.
	2	GND	Connects to ground.	Connected in parallel with ACC(2) pin 2.
	3	SEND	Input/output pin. Goes to ground when transmitting. When grounded, transmit.	Ground level: -0.5 to 0.8 V Input current: Less than 20 mA Connected in parallel with ACC(2) pin 3.
	4	MOD	Modulator input. Usable when pin 3 is grounded.	Input impedance: 10 kΩ Input level: Approx. 100 mV rms
	5	AF	AF detector output. Fixed, regardless of [AF] position.	Output impedance: 4.7 kΩ Output level: 100-300 mV rms
	6	SCAN	Starts scan when grounded.	Scan operation: Less than 0.6 V
	7	13.6 V	13.6 V output when power is ON.	Output current: Max. 1 A Connected in parallel with ACC(2) pin 7.
	8	ALC	ALC voltage	Control voltage: -3 to 0 V Input impedance: More than 10 kΩ Connected in parallel with ACC(2) pin 5.

*ACC(1): Marine and general versions only.

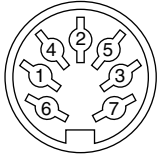
ACC(2)*/ACC*	PIN	PIN NAME	DESCRIPTION	SPECIFICATIONS
	1	8 V	Regulated 8 V output.	Output voltage: 8 V ±0.3 V Output current: Less than 10 mA
	2	GND	Same as ACC(1) pin 2.	
	3	SEND	Same as ACC(1) pin 3.	
	4	NC	No connection.	
	5	ALC	Same as ACC(1) pin 8.	
	6	RLC	T/R relay control output.	When transmitting: 0 V (less than 0.5 A)
	7	13.6 V	Same as ACC(1) pin 7.	

*ACC(2): Marine and general version; ACC: GMDSS version.

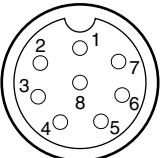
MICROPHONE	PIN	PIN NAME	DESCRIPTION	SPECIFICATIONS
	1	MIC+	Audio input from the microphone element.	Input impedance: 600 Ω
	2	NC	No connection.	
	3	AF1	AF output controlled with [VOLUME]. Connected to pin 4 in the microphone.	
	4	AF2	AF input. Connected to pin 3 in the microphone.	
	5	PTT	PTT switch input.	When grounded, transmits.
	6	GND	Connected to ground.	
	7	MIC-	Coaxial ground for MIC+.	
	8	AF-	Coaxial ground for AF1 and AF2.	

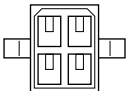
TUNER	PIN	PIN NAME	DESCRIPTION	SPECIFICATIONS
	1	KEY	Key signal input.	-0.5 to 0.8 V during tuning.
	2	START	Start signal output.	Pulled up 8 V, 0 V (100 msec) as a start signal.
	3	13.6V	13.6 V output.	Maximum current: 2 A
	4	E ANTC	Negative terminal. Antenna current input.	USA version (See below for Europe version.) Input level: Approx. 2 V rms

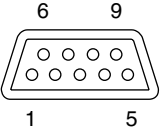
DSC	PIN	PIN NAME	DESCRIPTION	SPECIFICATIONS
	1	DMD+	Modulation input from a DSC terminal unit.	Input impedance: 600 Ω Input level: Approx. 0.75 V rms
	2	DMD-	Coaxial ground for DMD+.	
	3	DAF+	AF detector output for a DSC terminal unit.	Input impedance: 600 Ω Input level: Approx. 0.25–2.5 V rms
	4	DAF-	Coaxial ground for DAF+.	
	5	NMI+	NMEA data output.	NMEA standard format/level.
	6	NMI-	Coaxial ground for NMI+.	
	7	NMO+	NMEA data output.	NMEA standard format/level.
	8	NMO-	Coaxial ground for NMO+.	
	9	GND	Ground for digital equipment.	

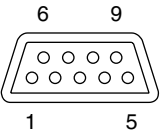
MOD/AF	PIN	PIN NAME	DESCRIPTION	SPECIFICATIONS
	1	NMD+	Modulation input for an external terminal unit.	Input impedance: 600 Ω Input level: Approx. 100 mV rms
	2	NMD-	Coaxial ground for NMD+.	
	3	NAF+	AF detector output for an external terminal unit.	Input impedance: 600 Ω Input level: Approx. 0.25–2.5 V rms
	4	NAF-	Coaxial ground for NAF+.	
	5	NSEN	Transmits when grounded.	Ground level: 0.5 to 0.8 V Input level: Less than 20 mA
	6	NC-	No connection.	
	7	NC	No connection.	
	8	NC-	No connection.	
	9	GND	Ground for digital equipment.	

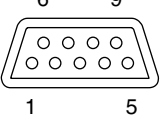
REMOTE	PIN	PIN NAME	DESCRIPTION	SPECIFICATIONS
	1	MOD+	Modulation input from an external terminal unit.	Input impedance: 600 Ω Input level: Approx. 100 mV rms
	2	MOD-	Coaxial ground for MOD+.	
	3	AF+	AF detector output for an external terminal unit.	Input impedance: 600 Ω Input level: Approx. 0.25–2.5 V rms
	4	AF-	Coaxial ground for AF+.	
	5	NMI+	NMEA data input.	NMEA standard format/level.
	6	NMI-	Coaxial ground for NMI+.	
	7	NMO+	NMEA data output.	NMEA standard format/level.
	8	NMO-	Coaxial ground for NMO+.	
	9	GND	Ground for digital equipment.	

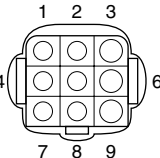
DC 13.6V	PIN	PIN NAME	DESCRIPTION	SPECIFICATIONS
	1,4,7	⊕	DC input (positive).	Max. power consumption: 30 A
	2,5,8	⊖	DC input (negative).	

Ground connection

The transceiver, remote controller RC-21 and antenna tuner MUST have an adequate ground connection. Otherwise, the overall efficiency of the transceiver and antenna tuner installation will be reduced. Electrolysis, electrical shocks and interference from other equipment could also occur.

For best results, use the heaviest gauge wire or strap available and make the connection as short as possible. Ground the transceiver, RC-21 and antenna tuner to one ground point, otherwise voltage differences between 2 ground points may cause electrolysis.

CAUTION: The IC-M710RT has either a negative ground or floating ground depending on version. NEVER connect the negative ground type to a “plus-grounding ship,” otherwise the transceiver will not function.

Ground system example

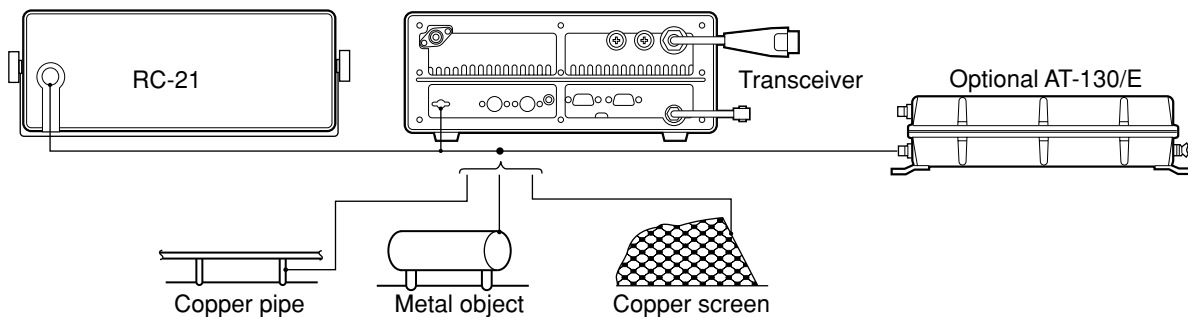

Good ground points

- Ship's ground terminal
- External ground plate
- External copper screen

Acceptable ground points

- Stainless steel tuna tower
- Stainless steel stanchion
- Through mast
- Through hull
- Metal water tank

Undesirable ground points

(these points may cause electrolysis)

- Engine block
- Keel bolt

Unusable ground points

(these connections may cause an explosion or electrical shock)

- Gas or electrical pipe
- Fuel tank or oil-catch pan

Power source

The transceiver requires regulated DC power of 13.6 V and at least 30 A. There are 3 ways to supply power:

- Direct connection to a 12 V battery in your ship through the supplied DC power cable.
- Use the PS-60 DC POWER SUPPLY to connect to an AC outlet.
- Use the PS-66 DC-DC CONVERTER to connect to a 19–32 V DC power source.

CAUTION: The supplied DC power cable MUST be used to provide power to the transceiver. AVOID exceeding the 3 m (10 ft) length of the DC power cable. If it is necessary to make a run of over 3 m, use #6 or similar weight cable instead of the supplied DC power cable for a maximum run of 6 m (20 ft).

DC power cable connection

NOTE: Use terminals for the cable connection.

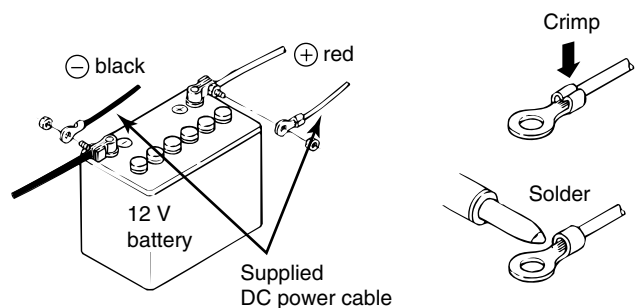

■ Antenna

Most stations operate with a whip or long wire (insulated backstay) antenna. However, these antennas cannot be connected directly to the transceiver since their impedance may not be matched with the transceiver antenna connector.

With a 50 Ω matched antenna all marine bands cannot be used. The following antenna matcher or antenna tuner may be helpful for antenna installation.

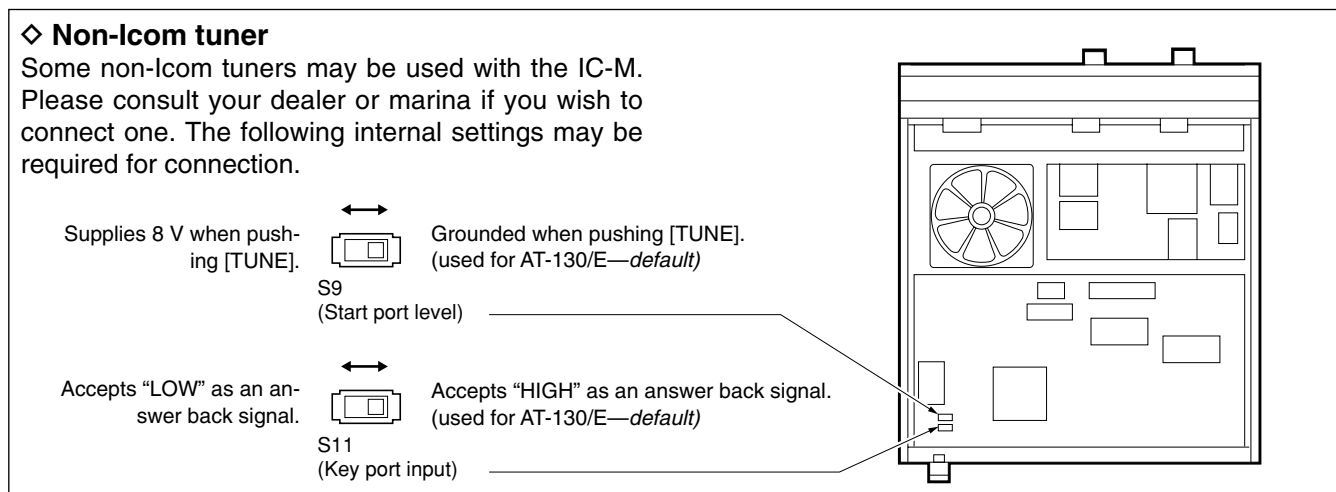
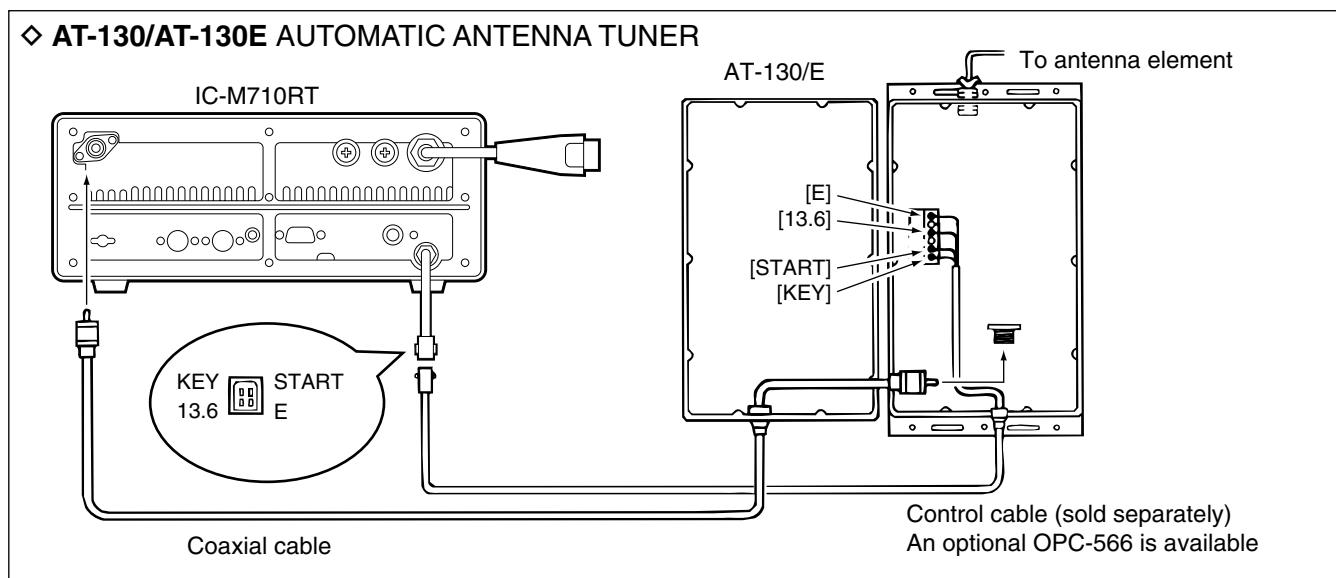
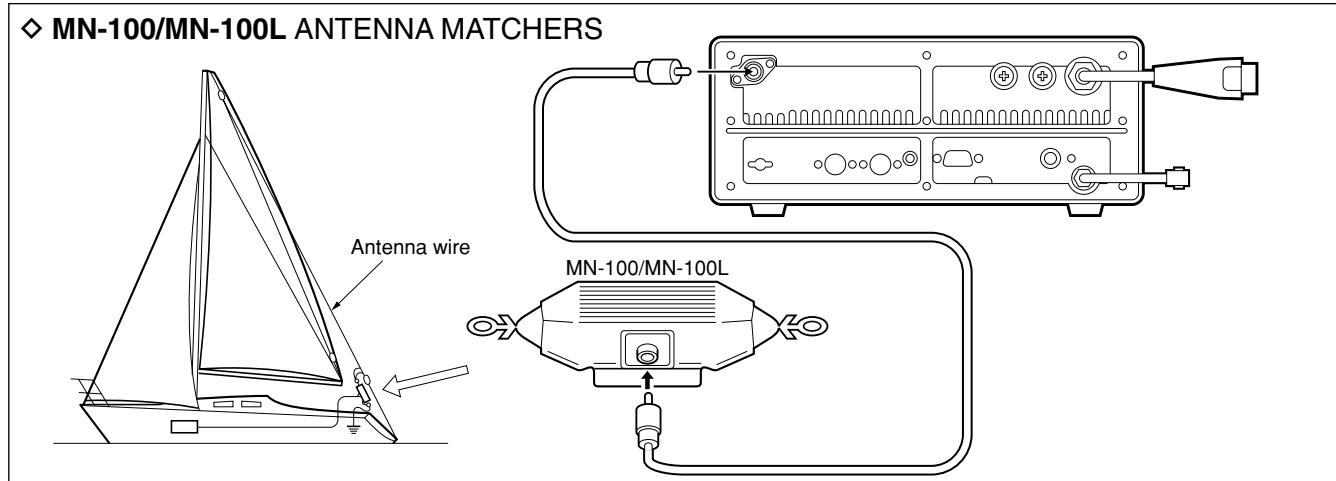

■ Mounting

◇ Mounting location

Select a location that provides easy access to the front panel for navigation safety, has good ventilation and is not subject to sea spray. The controller should be at 90 degrees to your line of sight when operating it.

CAUTION: KEEP the transceiver and microphone at least 1 meter away from your vessel's magnetic navigation compass.

Check the installation angle; the display may not be easy to read at some angles.

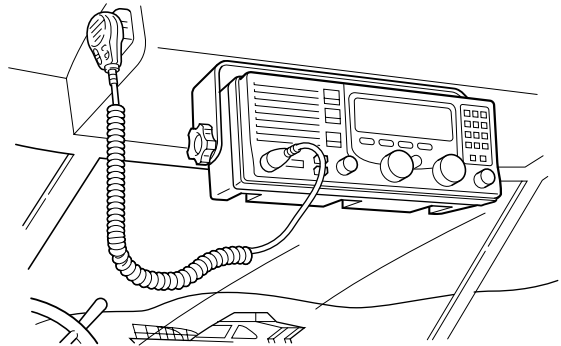
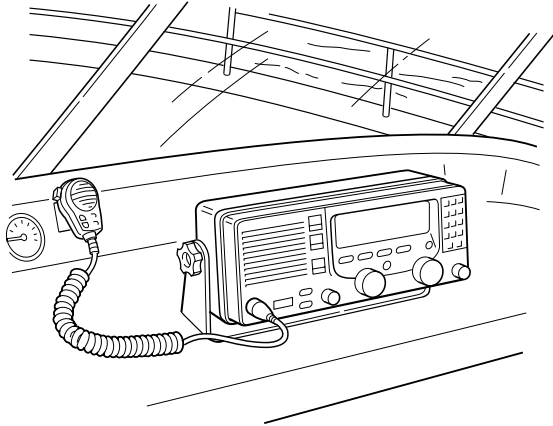

◇ Mounting the controller/main body

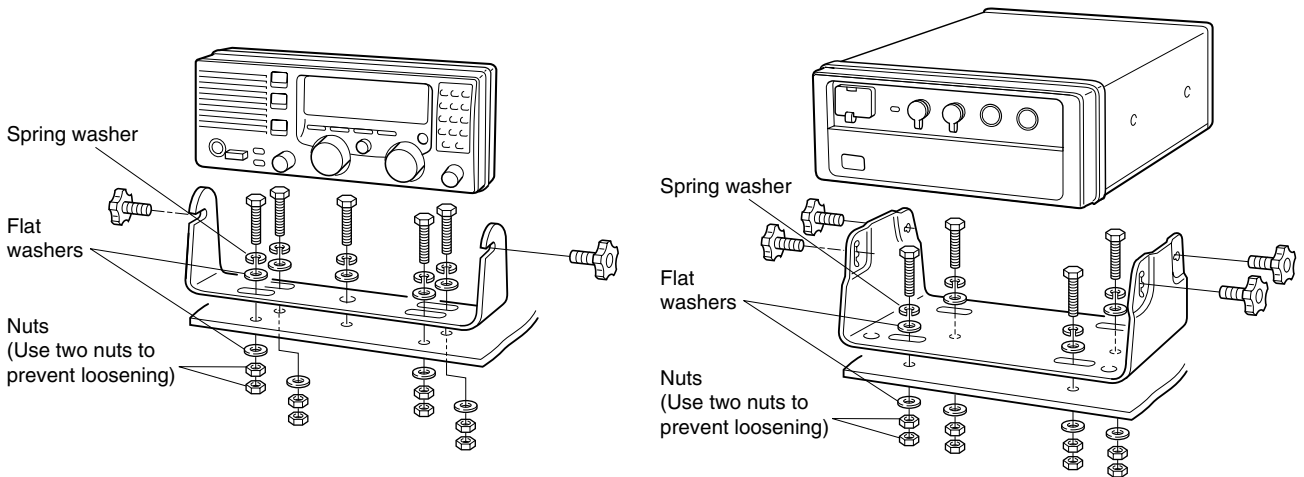

◇ Transceiver dimensions

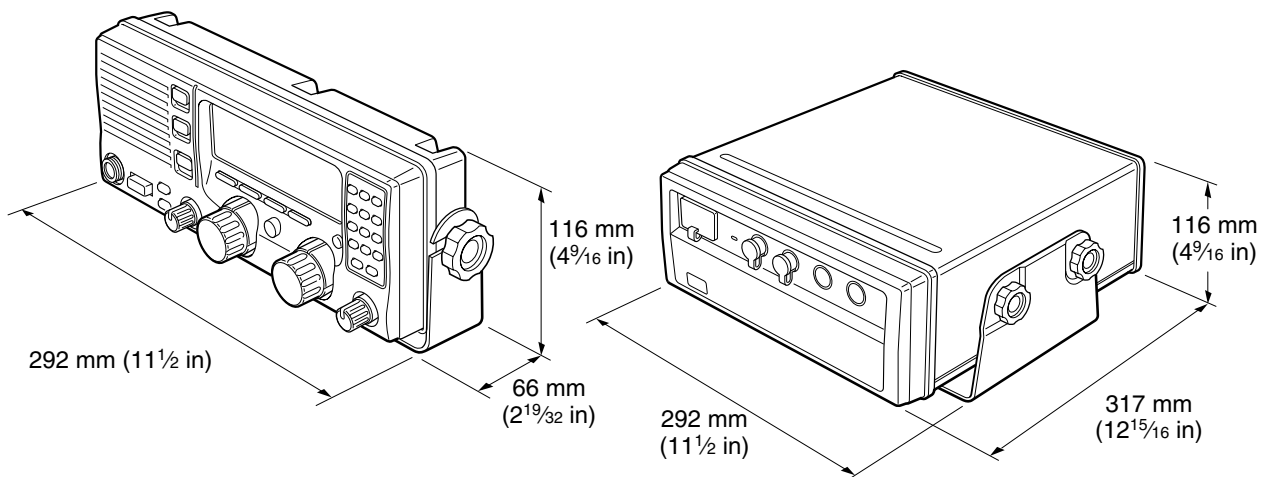

■ Installing internal options

◇ Opening the case

Follow the case and cover opening procedures shown here when you want to install an option or adjust a setting for non-Icom tuner control.

- ① Remove the 9 screws from the rear panel, then remove the rear frame and rear sealing.
- ② Remove the transceiver case.
- ③ When reassembling the transceiver, check the following points:
 - Internal fan and slits in the case are on the same side.
 - Front sealing is mated correctly.
 - Rear sealing is attached in the proper orientation.
 - Screws are tightened securely.

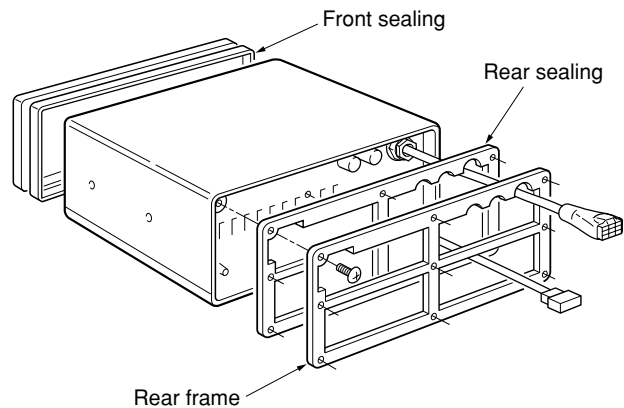

◇ Installing an optional filter and alarm unit

After opening the case as shown above, install the desired option to the position as at right. These options are available (or already built-in) for the following versions:

Version	Marine	General
FL-100 CW/FSK NARROW FILTER	optional	optional
UT-95 2-TONE ALARM UNIT	built-in	optional

After installing the 2-tone alarm unit into a General version, remove the plastic cover on the [ALARM] switch to use the switch.

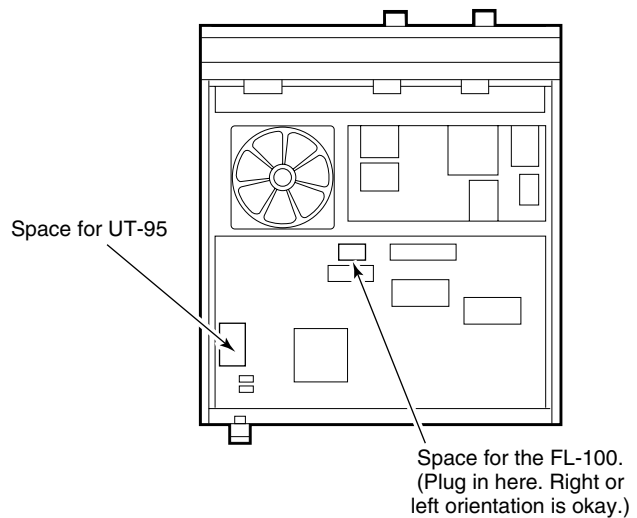

■ Fuse replacement

The transceiver has 3 fuses to protect internal circuitry, 2 fuses for the fuse holder on the rear panel and 1 for inside. If the transceiver stops functioning, check the fuses below.

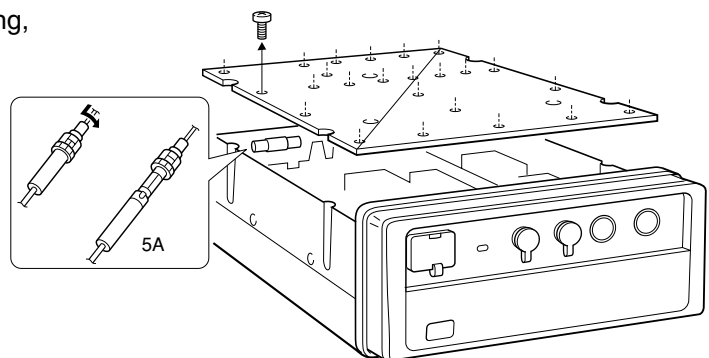
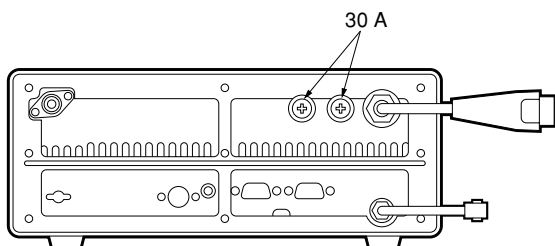

What appears to be equipment malfunction may not be damaging or difficult to solve. Check the following chart before making any adjustments or sending the transceiver to an Icom Service Center.

	PROBLEM	POSSIBLE CAUSE	SOLUTION	REF.
POWER	Power does not come on when [POWER] is pushed.	<ul style="list-style-type: none"> • Power cable is improperly connected. • Blown fuse. 	<ul style="list-style-type: none"> • Reconnect the cable securely. • Check for cause, then replace the fuse with a spare one. 	p. 19 p. 25
	RECEIVE	No sound comes from the speaker.	<ul style="list-style-type: none"> • The [SPEAKER] switch is turned ON. • Microphone is not connected. • RF gain is set too deeply and several segments of the S-meter appear. • The squelch is closed. 	<ul style="list-style-type: none"> • Turn OFF the [SPEAKER] switch. • Connect the microphone to the [MICROPHONE] connector. • Push [FUNC], then [RX] to reset the RF gain. (RF GAIN 9 applies audio.) • Push [SQL] switch to turn the squelch OFF.
Sensitivity is low and only strong signals are audible.		<ul style="list-style-type: none"> • Antenna is not properly matched to the operating frequency. • RF gain is set too deeply. • Wrong tuner condition is selected in set mode. 	<ul style="list-style-type: none"> • Push [TUNE] to tune the connected antenna tuner or select "automatic tuning" using set mode when an optional AT-130/E is connected. • Push [FUNC], then [RX] to reset the RF gain. • Set to the proper condition for the connected tuner. 	p. 13 p. 10 p. 13
Received audio is unclear or distorted.		<ul style="list-style-type: none"> • Wrong type of emission is selected. • AGC is deactivated while receiving a strong signal. • Noise blanker is turned ON when receiving a strong signal. • The [CLARITY] control is rotated too far clockwise or counterclockwise. 	<ul style="list-style-type: none"> • Push [MODE] to select the proper operating mode. • Push [AGC] to activate the AGC function. • Push [NB] to turn the noise blanker OFF. • Adjust the [CLARITY] control to receive proper audio output. 	p. 9 p. 10 p. 10 p. 10
TRANSMIT	Your signal does not reach as far away as usual.	<ul style="list-style-type: none"> • The transmit power is set low. • Antenna tuner is improperly matched to the operating frequency when manual tuning is selected. • CW or FSK mode is selected for voice transmission. 	<ul style="list-style-type: none"> • Push [FUNC], then [TX] to reset the transmit power. (RF-PWR 3 is maximum power.) • Push [TUNE] to tune the connected antenna tuner or select "automatic tuning" using set mode. • Push [MODE] to select J3E mode (or H3E, R3E, etc.). 	p. 9 p. 9 or p. 13 p. 9
	Transmit signal is unclear or distorted.	<ul style="list-style-type: none"> • Wrong type of emission is selected. • Microphone is too close to your mouth. 	<ul style="list-style-type: none"> • Push [MODE] to select the proper operating mode. • Speak into the microphone naturally and do not hold the microphone too close to your mouth. 	p. 9 —
	No contact is possible with another station.	<ul style="list-style-type: none"> • Wrong transmit frequency is set. 	<ul style="list-style-type: none"> • Push [TX FREQ] to check and store the correct transmit frequency. 	p. 8
DISPLAY	Frequency cannot be set via the keypad.	<ul style="list-style-type: none"> • The [CE] key is not pushed ("▶" does not appear) before digit entry. • 2182 kHz is selected with the [2182KHz] switch. 	<ul style="list-style-type: none"> • Push [CE] ("▶" appears), then enter the desired frequency. • Push [2182KHz], then set the frequency. 	p. 8 p. 6
	FSK ITU channels cannot be selected.	<ul style="list-style-type: none"> • SITOR operation is set OFF in set mode. 	<ul style="list-style-type: none"> • Set "SITOR" to ON in set mode. 	p. 13

■ Specifications

GENERAL

- Frequency coverage:
 - Receive 500 kHz–29.999 MHz
 - Transmit 1.6–27.5 MHz
- Mode: J3E (USB/LSB), H3E, J2B (AFSK), F1B (FSK), R3E, A1A (CW); available modes differ with version
- Number of channels: 1136 channels (max.)
 - 160 user programmable, 242 ITU SSB duplex, 72 ITU SSB simplex, 662 ITU FSK duplex
- Antenna impedance: 50 Ω nominal
- Usable temp. range: –30°C to +60°C (–22°F to +140°F)
- Frequency stability (–20°C to +60°C):
 - 0.5–14.9999 MHz ±10 Hz
 - 15–29.9999 MHz ±20 Hz (GMDSS ±10 Hz)
- Power supply requirement: 13.6 V DC±15%
 - (negative and floating grounds available depending on version)
- Maximum current drain (at 13.8 V DC):
 - Main unit 30 A (transmit at max. power)
 - Controller 1.2 A (receive at max. audio)
- Dimensions (projections not included):
 - Main unit 292(W)×117(H)×317(D) mm
11½(W)×4½(H)×12½(D) in
 - Controller 292(W)×116(H)×66(D) mm
11½(W)×4½(H)×2½(D) in
- Weight:
 - Main unit 7.45 kg; 16 lb 7 oz (negative ground)
(7.65 kg; 16 lb 14 oz GMDSS version)
 - Controller 1.2 kg; 2 lb 12 oz

■ Options

GM-110DSC DSC TERMINAL UNIT

6 channel emergency scanning receiver for distress calls, selective calls, etc. Distress switch box attached.

AT-130/E AUTOMATIC ANTENNA TUNER

Matches the transceiver to a long wire antenna with a minimum of insertion loss.

OPC-566 SHIELDED CONTROL CABLE

Shielded control cable helps protect the transceiver from RF feedback and extends separation between tuner and transceiver up to 10 m.

MN-100 ANTENNA MATCHER

Matches the transceiver to a dipole antenna. Covers all HF bands from 1.5 to 30 MHz. 8 m × 2 antenna wires come attached.

MN-100L ANTENNA MATCHER

Matches the transceiver to a dipole antenna. Covers all HF bands from 1.5 to 30 MHz. 15 m × 1 antenna wire comes attached.

AH-710 FOLDED DIPOLE ANTENNA

Covers from 1.9 to 30 MHz band. Has an SO-239 connector. Easy to assemble (non-kink construction).

PS-60 DC POWER SUPPLY

Provides 13.6 V DC (30 A) output from an AC outlet.

PS-65/66 DC-DC CONVERTER

Provides 13.6 V DC (30 A) output from a 10.5–16 V (PS-65) or 19–32 V (PS-66) DC power source.

TRANSMITTER

- Output power:
 - Below 25 MHz 150/60/20*¹ W PEP
125 W PEP (GMDSS only*²)
 - Above 25 MHz 60/20*¹ W PEP
85 W PEP (GMDSS only*²)

*¹Except for Europe versions. *²The output power of GMDSS versions is provided by the AT-130/E antenna tuner.

- Spurious emissions: –65 dB (USA); –60 dB (Europe)
- Carrier suppression: 40 dB
- Unwanted sideband suppression: 55 dB
- Microphone impedance: 600 Ω

RECEIVER

- Sensitivity :
 - J3E, R3E, J2B, A1A, F1B 6.3 μV (0.5–1.5999 MHz)
 - (for 12 dB SINAD) 1.0 μV (1.6–1.7999 MHz)
 - 0.5 μV (1.8–29.9999 MHz)
 - H3E 32 μV (0.5–1.5999 MHz)
 - (for 10 dB S/N) 6.3 μV (1.6–1.7999 MHz)
 - 3.2 μV (1.8–19.9999 MHz)
- Spurious response rejection ration:
 - (1.6–29.9999 MHz) More than 70 dB
- Audio output power: 4.5 W (at 10% distortion with a 4 Ω load)
- Audio output impedance: 4 to 8 Ω
- Clarity variable range: ±150 Hz

All stated specifications are subject to change without notice or obligation.

RC-21 CONTROLLER UNIT

Additional controller unit allows intercom function. Up to 2 controller unit can be connected.

HS-50 HANDSET

Provides better audio reception during offshore conditions and comes in handy for listening privacy on board.

HM-120 HAND MICROPHONE

Same as supplied with some versions of the IC-M710RT.

FL-100 CW/FSK NARROW FILTER

Allows better receiver selectivity for CW and FSK.

Bandwidth: 500 Hz/–6 dB

Not necessary with GMDSS versions.

UT-95 2-TONE ALARM UNIT

Provides an alarm transmission for emergency use during maritime operation. Built-in to marine and GMDSS versions.

OPC-772 SEPARATION CABLE

For extending the separation between the controller and main unit. Cable length: 20 m (67.4 ft).

RS-M710RT REMOTE CONTROL SOFTWARE

Controls the IC-M710RT from your PC. Microsoft® Windows® 95 only.

MB-70 FLUSH MOUNT KIT

For mounting a controller or the RC-21 to a panel.

Count on us!



Icom America Inc.

<Corporate Headquarters>
2380 116th Avenue N.E., Bellevue, WA 98004, U.S.A.
Phone : (425) 454-8155 Fax : (425) 454-1509
URL : <http://www.icomamerica.com>

<Customer Service>
Phone : (425) 454-7619

Icom (Europe) GmbH

Communication Equipment
Himmelgeister Str. 100,
D-40225 Düsseldorf, Germany
Phone : 0211 346047 Fax : 0211 333639
URL : <http://www.icomeurope.com>

Icom Canada

A Division of Icom America Inc.
3071 #5 Road, Unit 9, Richmond, B.C.,
V6X 2T4, Canada
Phone : (604) 273-7400 Fax : (604) 273-1900

Icom Telecomunicaciones s.l.

"Edificio Can Castanyer" Crta.
Gracia a Manresa km. 14,750
08190 Sant Cugat Del Valles Barcelona, SPAIN
Phone : (3) 589 46 82 Fax : (3) 589 04 46
E-mail : icom@lleida.com

Icom (Australia) Pty. Ltd.

A.C.N. 006 092 575
290-294 Albert Street, Brunswick,
Victoria, 3056, Australia
Phone : 03 9387 0666 Fax : 03 9387 0022

Icom (UK) Ltd.

Unit 9, Sea St., Heme Bay, Kent, CT6 8LD, U.K.
Phone : 01227 741741 Fax : 01227 741742
URL : <http://www.icomuk.co.uk>

Asia Icom Inc.

6F No. 68, Sec. 1 Cheng-Teh Road,
Taipei, Taiwan R.O.C.
Phone : (02) 2559 1899 Fax : (02) 2559 1874

Icom France Sa

Zac de la Plaine, Rue Brindejonc des Moulinais
BP 5804, 31505 Toulouse Cedex, France
Phone : 561 36 03 03 Fax : 561 36 03 00
URL : <http://www.icom-france.com>
